

△ SPECIFICATION

Voltage Rating:250V AC
 Current Rating:10 Amp/Way Max.
 Contact Resistance:20 Milliohms Max.
 Insulation Resistance:5000 Megohms/1000V
 Withstanding Voltage:1500V AC(1 Minute) Test Time=60Sec./1PCS
 Wire Range:12~26AWG
 Torque:4.3 kgf.cm/M3
 Operation Temperature:-40°C~+120°C
 Contact(Metal Housing):Copper Alloy
 Terminal Screw:Steel,Galvanized With Cr3+ Plated
 Wire Guard:Copper Alloy,Tin Plated
 Insulator Body(Housing):Polyamide(Glass Filled)(UL94V-0),Green
 RoHS Compliant

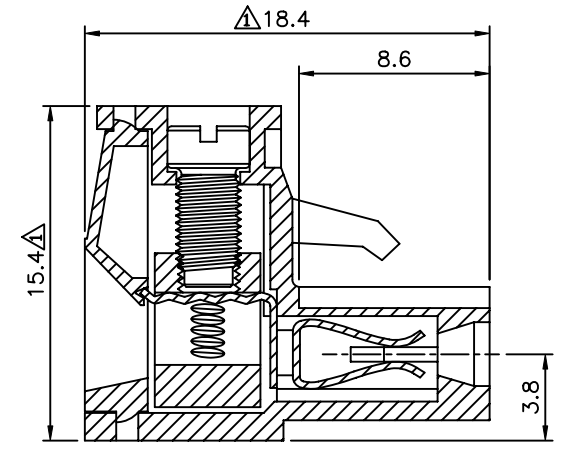
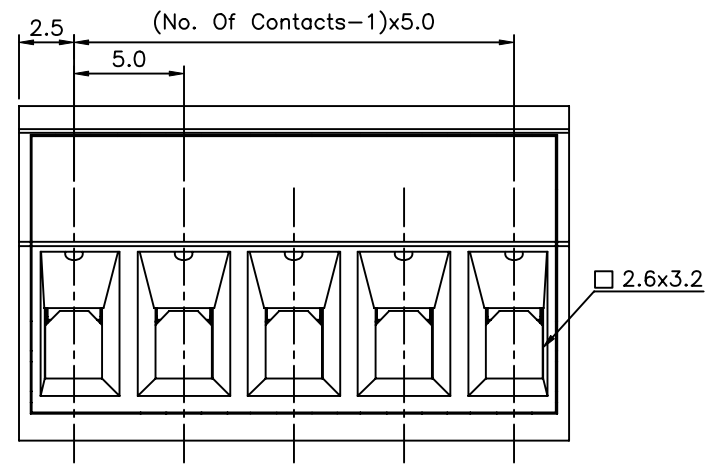
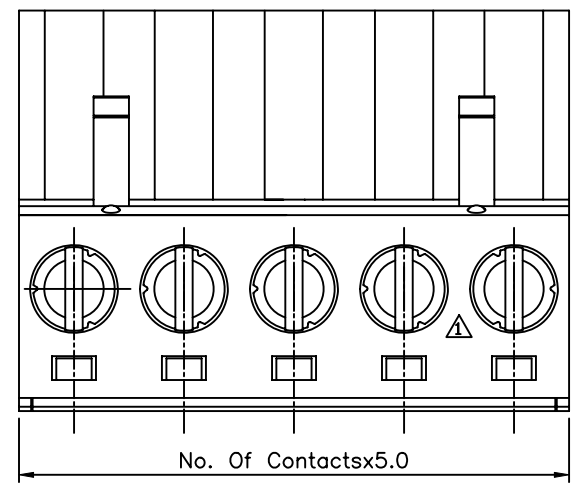

4UCON 元化興業股份有限公司
 4UCON TECHNOLOGY INC.

DRAWING No.
 05308

APPROVED BY MEI
 CHECKED BY HZF
 DRAWING BY WZL

UNLESS OTHERWISE SPECIFIED TOLERANCES ARE
 X. ±0.50
 .X ±0.30
 .XX ±0.20
 ANG. ±1°

SCALE NONE

REV. A1

UNIT mm

NO.	REV.	REVISIONS	CHK	DATE
△ A1		Modify Data	HZF	07/13/2010
△ A0		NEW RELEASE	HZF	05/13/2009