

**SPECIFICATION**

- 1.General Characteristics**  
1.0mm FPC XXP DIP 180° Non-ZIF Dual Contact  
Reverse Layout Withstand High Temperature
- 2.Material&Finish**  
Housing:PA9T(UL94V-0),Black  
Contact:Phosphor Bronze,Tin Plated Over Nickel
- 3.Electrical Characteristics**  
Current Rating:0.5A Max.  
Voltage Rating:50V AC  
Contact Resistance:30 Milliohms Max.(Initial)  
50 Milliohms Max.(Final)  
Insulation Resistance:500 Megaohms Min.(Initial) At 500V DC  
Dielectric Voltage:500V AC For One Minute
- 4.Environmental Characteristics**  
Temperature Range:-20°C~+85°C
- 5.RoHS Compliant**

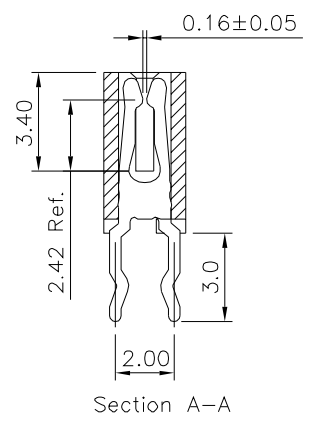
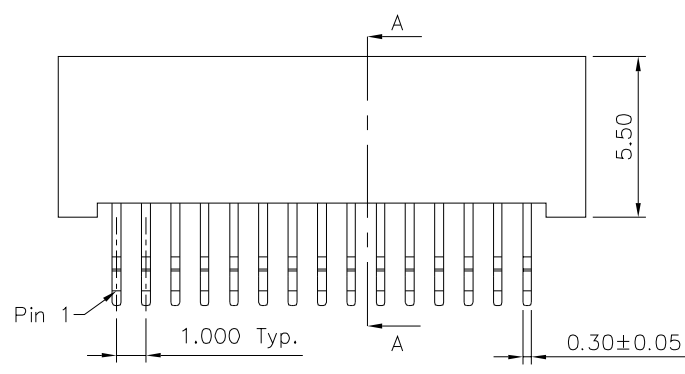
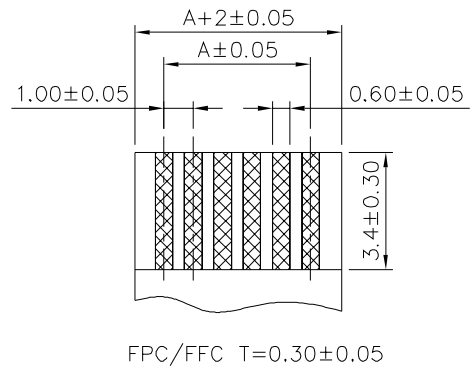
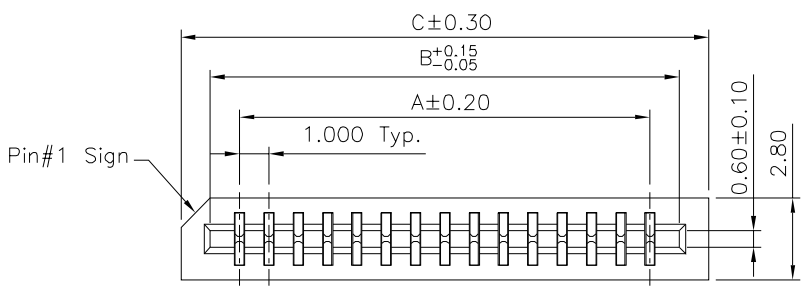
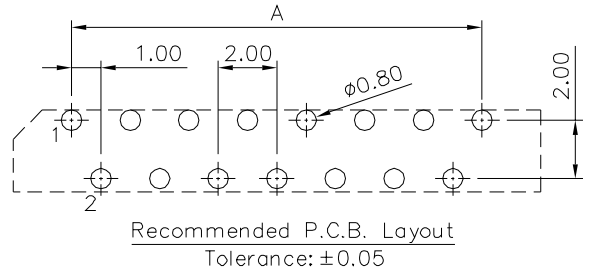

Pin	A	B	C	Pin	A	B	C
03	2.00	4.10	6.00	18	17.00	19.10	21.00
04	3.00	5.10	7.00	19	18.00	20.10	22.00
05	4.00	6.10	8.00	20	19.00	21.10	23.00
06	5.00	7.10	9.00	21	20.00	22.10	24.00
07	6.00	8.10	10.00	22	21.00	23.10	25.00
08	7.00	9.10	11.00	23	22.00	24.10	26.00
09	8.00	10.10	12.00	24	23.00	25.10	27.00
10	9.00	11.10	13.00	25	24.00	26.10	28.00
11	10.00	12.10	14.00	26	25.00	27.10	29.00
12	11.00	13.10	15.00	27	26.00	28.10	30.00
13	12.00	14.10	16.00	28	27.00	29.10	31.00
14	13.00	15.10	17.00	29	28.00	30.10	32.00
15	14.00	16.10	18.00	30	29.00	31.10	33.00
16	15.00	17.10	19.00	32	31.00	33.10	35.00
17	16.00	18.10	20.00				

**4UCON** 元化興業股份有限公司  
4UCON TECHNOLOGY INC.

DRAWING No.		APPROVED BY		UNLESS OTHERWISE SPECIFIED TOLERANCES ARE X. $\pm 0.40$ .X $\pm 0.30$ .XX $\pm 0.20$ .XXX $\pm 0.10$
06292		MEI		
		CHECKED BY	HZF	
		DRAWING BY	CYP	
SCALE	NONE	REV.	BO	UNIT mm

NO.	REV.	BO	NEW RELEASE	HZF	09/01/2017
			REVISIONS	CHK	DATE