

Recommended P.C.B. Layout

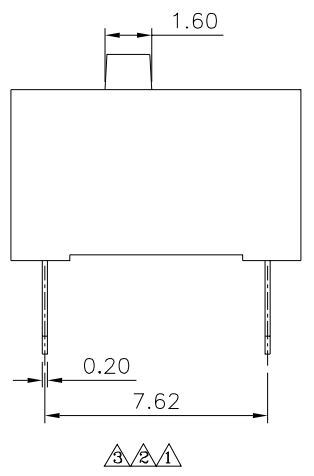
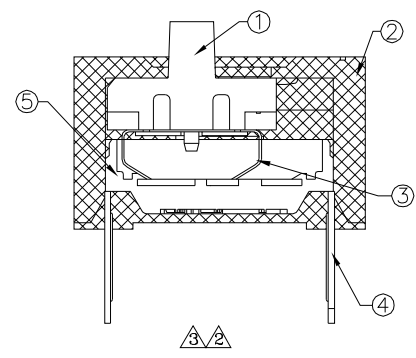
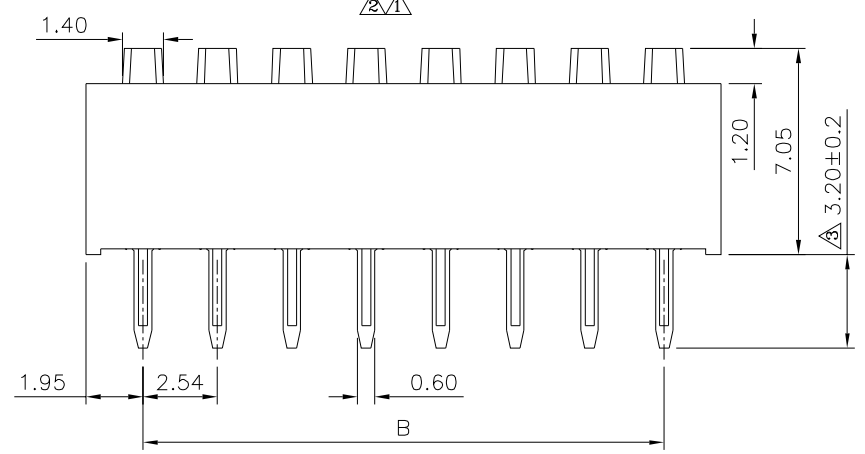
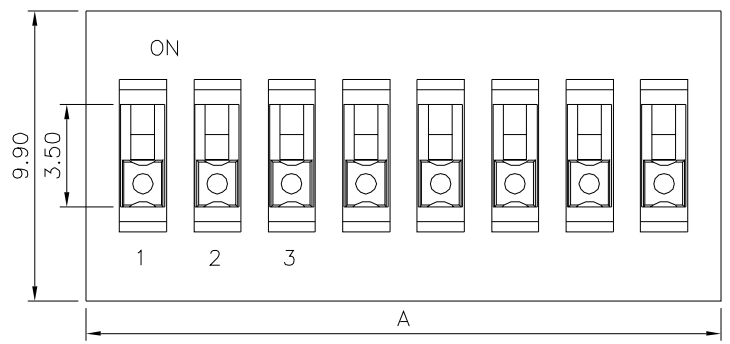

△ SPECIFICATION

Current Range:
 Non-Switching: 100mA 50V DC
 Switching: 25mA 24V DC
 Withstanding Voltage: 500V AC 50Hz Or
 60Hz For 1 Minute
 Contact Resistance: 50 Milliohms Max. (Initial)
 Insulation Resistance: 100 Megaohms Min.
 At 500V DC, 60s ± 5s
 Operation Temperature Range: -40°C ~ +85°C
 Operation Force: 9.8N Max.
 Switch Position: Off Type
 RoHS Compliant

Pin	A	B
1	3.90	
2	6.44	2.54
3	8.98	5.08
4	11.52	7.62
5	14.06	10.16
6	16.60	12.70
7	19.14	15.24
8	21.68	17.78
9	24.22	20.32
10	26.76	22.86
12	31.84	27.94

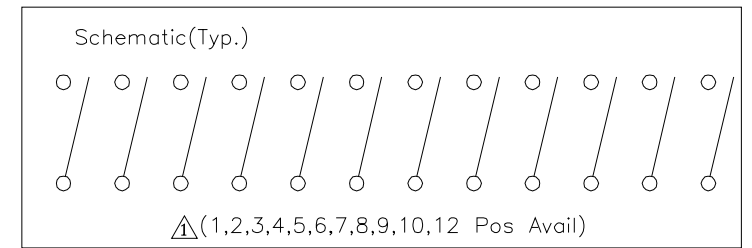

No.	Description	Q'ty	Material	Remark
⑤	Base	1	PA66,UL94V-0	Black
④	Terminal	-	Brass	Gold Plated Over Nickel
③	Contact	-	Copper Alloy	Gold Plated Over Nickel
②	Cover	1	PBT,UL94V-0	Blue
①	Actuator	-	PBT,UL94V-0	White

4UCON 元化興業股份有限公司
 4UCON TECHNOLOGY INC.

DRAWING No. △		APPROVED BY		UNLESS OTHERWISE SPECIFIED TOLERANCES ARE ~10 ± 0.10 10~ ± 0.20
07234		MEI		
		CHECKED BY	HZF	
		DRAWING BY	CYP	
SCALE	NONE	REV.	B3	UNIT mm

NO.	REV.	REVISIONS	CHK	DATE
△3	B3	Modify Data	HZF	06/09/2023
△2	B2	Modify Data	HZF	07/10/2018
△1	B1	Modify Data	HZF	05/12/2016
△0	B0	NEW RELEASE	HZF	10/10/2013