

SPECIFICATION

Current Rating:1.0A
 Voltage Rating:50V AC
 Dielectric Withstanding Voltage:500V AC/Minute
 Temperature Range:-40°C~+105°C
 Contact Resistance:20 Milliohms Max.
 Insulation Resistance:100 Megaohms Min.
 Contact:Phosphor Bronze,Tin Plated
 Insulator:PA6T(UL94V-0),Nature
 RoHS Compliant

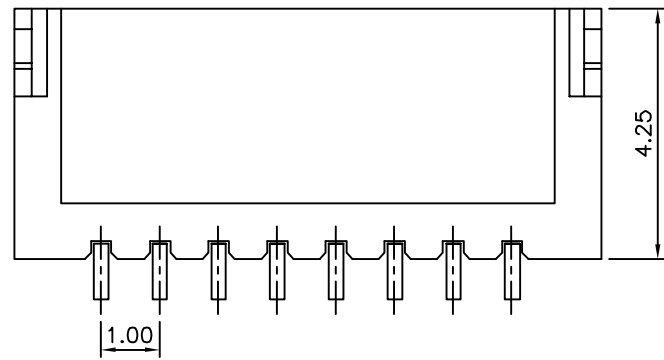
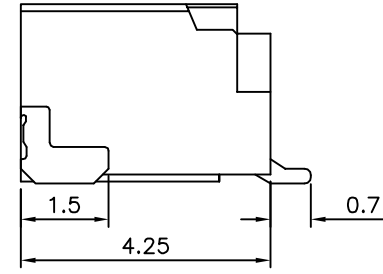
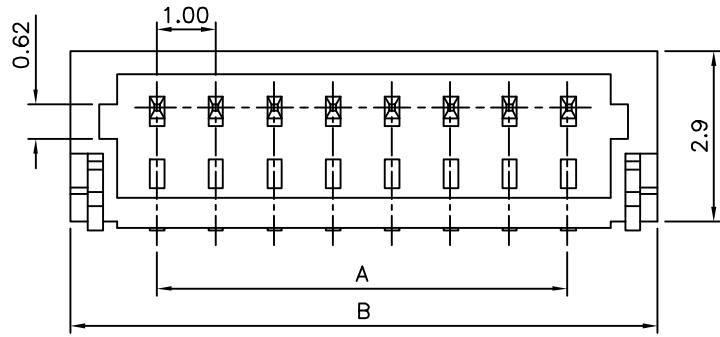
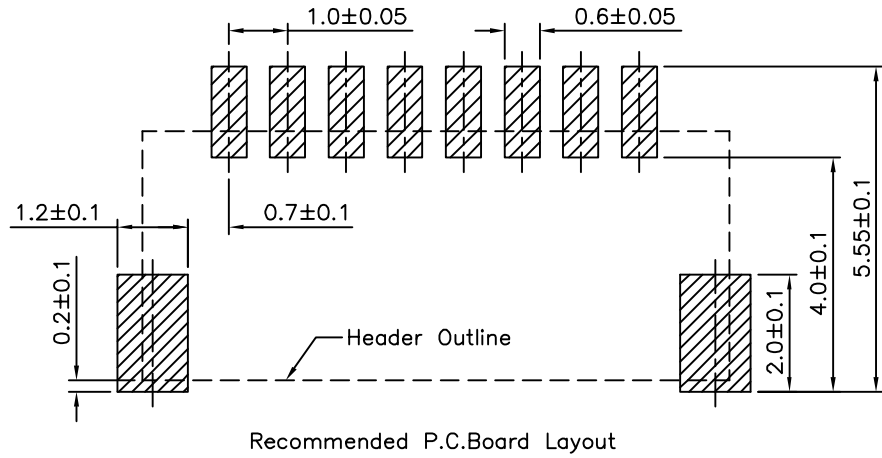

Pin	A	B
*2	1.0	4.0
*3	2.0	5.0
*4	3.0	6.0
*5	4.0	7.0
*6	5.0	8.0
*7	6.0	9.0
*8	7.0	10.0
*9	8.0	11.0
*10	9.0	12.0
*11	10.0	13.0
*12	11.0	14.0
*13	12.0	15.0
*14	13.0	16.0
*15	14.0	17.0
16	15.0	18.0
20	19.0	22.0

The Mark Of "*" Are Toolled Already

4UCON 元化興業股份有限公司
 4UCON TECHNOLOGY INC.

DRAWING No.		APPROVED BY		UNLESS OTHERWISE SPECIFIED TOLERANCES ARE .X ±0.25 .XX ±0.15 ANG.
07279		EMILY		
		HZF		
		DRAWING BY		UNIT mm
		SONG		
SCALE	NONE	REV.	A0	NO.REV.

△ A0	NEW RELEASE	HZF	07/15/2012
NO.REV.	REVISIONS	CHK	DATE