

**△△ SPECIFICATION**

- 1.General Characteristics**  
1.0 FPC XXP SMT 90° ZIF Top Contact
- 2.Material&Finish**  
Base:PA9T(UL94V-0)  
Slider:PPS(UL94V-0)  
Contact:Phosphor Bronze,Tin Plated Over Nickel  
Me:Brass,Tin Alloy Plated
- 3.Electrical Characteristics**  
Current Rating:0.5 Amp Max.  
Voltage Rating:100V AC Max.  
Contact Resistance:30 Milliohms Max.  
Insulation Resistance:500 Megaohms Min.  
Dielectric Withstanding Voltage:500V AC RMS
- 4.Environmental Characteristics**  
Operation Temperature:-40°C~+85°C  
Processing Temperature:260±5°C For 30s
- 5.Other**  
Accommodated FFC/FPC Thickness:0.25~0.35mm
- 6.RoHS Compliant**

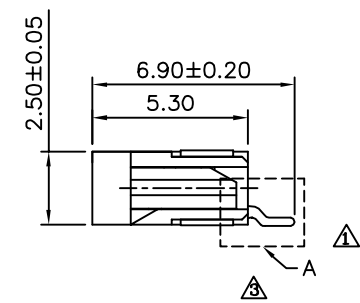
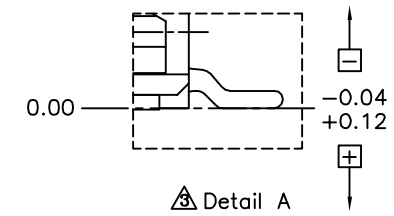
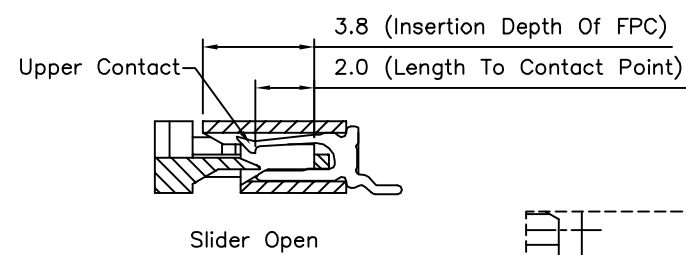
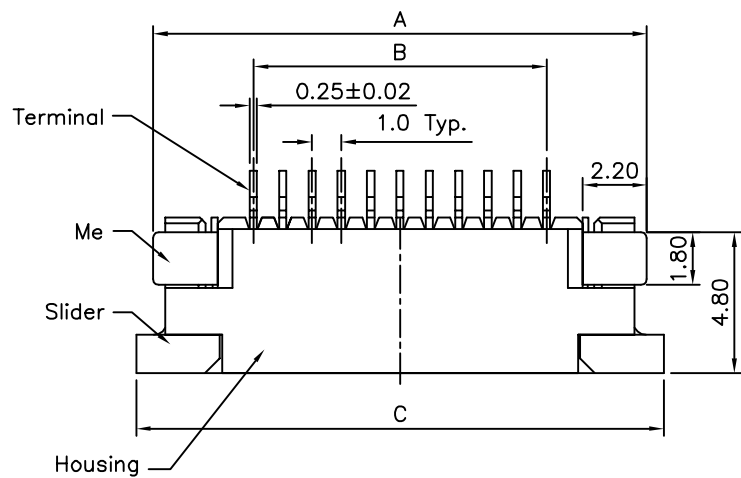
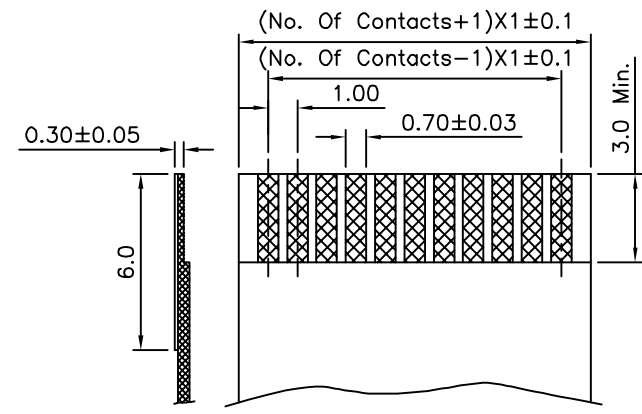
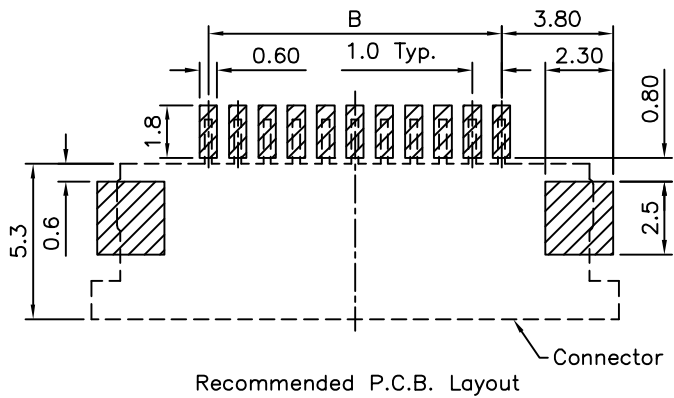

Pin	A±0.25	B±0.15	C±0.20	D±0.10
4	10.00	3.00	11.00	5.05
5	11.00	4.00	12.00	6.05
6	12.00	5.00	13.00	7.05
7	13.00	6.00	14.00	8.05
8	14.00	7.00	15.00	9.05
9	15.00	8.00	16.00	10.05
10	16.00	9.00	17.00	11.05
11	17.00	10.00	18.00	12.05
12	18.00	11.00	19.00	13.05
13	19.00	12.00	20.00	14.05
14	20.00	13.00	21.00	15.05
15	21.00	14.00	22.00	16.05
16	22.00	15.00	23.00	17.05
17	23.00	16.00	24.00	18.05
18	24.00	17.00	25.00	19.05
19	25.00	18.00	26.00	20.25
20	26.00	19.00	27.00	21.05
20	27.00	20.00	28.00	22.05
22	28.00	21.00	29.00	23.05
23	29.00	22.00	30.00	24.05
24	30.00	23.00	31.00	25.05
25	31.00	24.00	32.00	26.05
26	32.00	25.00	33.00	27.05
27	33.00	26.00	34.00	28.05
28	34.00	27.00	35.00	29.05
29	35.00	28.00	36.00	30.05
30	36.00	29.00	37.00	31.05
31	37.00	30.00	38.00	32.05
32	38.00	31.00	39.00	33.05
33	39.00	32.00	40.00	34.05
34	40.00	33.00	41.00	35.05

**4UCON** 元化興業股份有限公司  
4UCON TECHNOLOGY INC.

DRAWING No.		APPROVED BY		UNLESS OTHERWISE SPECIFIED TOLERANCES ARE △ .XX ±0.25 ANG.
07613		MEI		
		CHECKED BY	HZF	
		DRAWING BY		
		SONG		
SCALE	NONE	REV.	A4	UNIT mm

NO.	REV.	REVISIONS	CHK	DATE
△A4		Midify Data	HZF	07/20/2013
△A3		Midify Data	HZF	11/09/2010
△A2		Midify DIM A	HZF	10/22/2008
△A1		ADD DIM:0.9	HZF	04/07/2008
△A0		NEW RELEASE	HZF	05/15/2006