

Recommended P.C.B. Layout

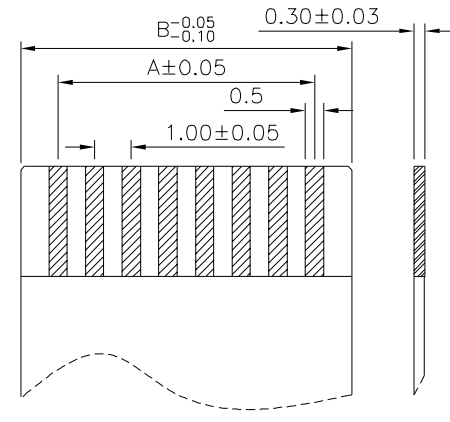

Accommodated FFC/FPC

**SPECIFICATION**  
**1.General Characteristics**  
 1.0mm FPC XXP SMT 90° ZIF Bottom Contact  
 Tape & Reel 1500 PCS/Reel  
**2.Material&Finish**  
 ① Insulator:LCP(UL94V-0),Nature  
 ② Terminal:Phosphor Bronze,Tin Plated  
 ③ Slider:LCP(UL94V-0),Black  
 ④ Latch:Brass,Tin Plated  
**3.Electrical Characteristics**  
 Voltage Rating:50V AC/DC  
 Contact Resistance:40 Milliohms Max.  
 Insulation Resistance:50 Megaohms Min.  
**4.Environmental Characteristics**  
 Temperature Range:-25°C~+85°C  
**5.RoHS Compliant**

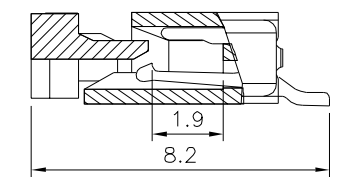
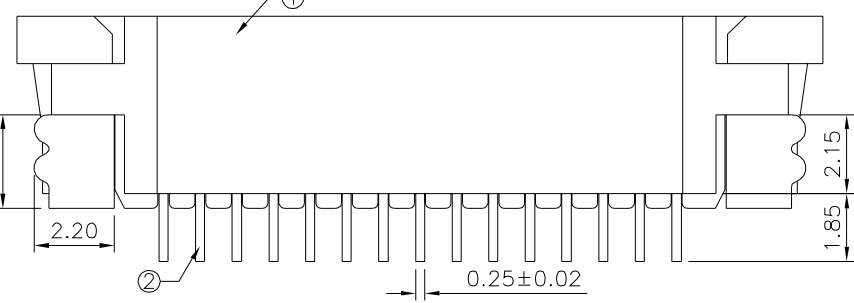
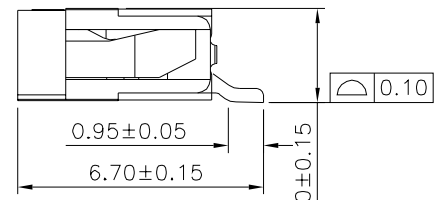
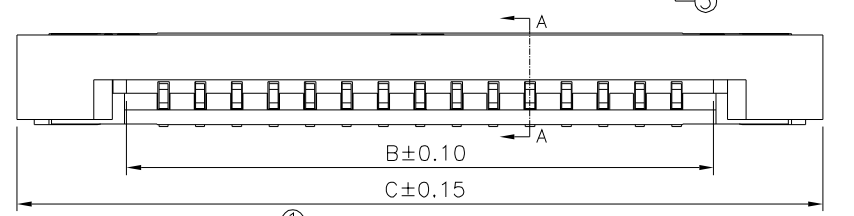
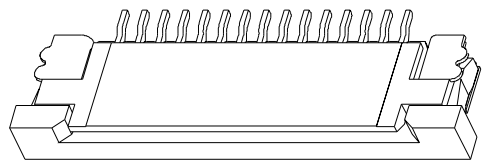
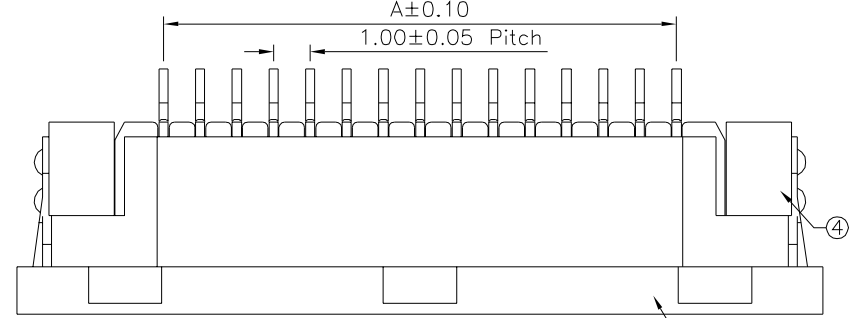

Section A-A

Pin	A	B	C	Pin	A	B	C
*4	3.00	5.03	11.00	23	22.00	24.03	30.00
*5	4.00	6.03	12.00	*24	23.00	25.03	31.00
*6	5.00	7.03	13.00	*25	24.00	26.03	32.00
7	6.00	8.03	14.00	*26	25.00	27.03	33.00
*8	7.00	9.03	15.00	27	26.00	28.03	34.00
*9	8.00	10.03	16.00	28	27.00	29.03	35.00
*10	9.00	11.03	17.00	29	28.00	30.03	36.00
11	10.00	12.03	18.00	*30	29.00	31.03	37.00
*12	11.00	13.03	19.00	31	30.00	32.03	38.00
*13	12.00	14.03	20.00	*32	31.00	33.03	39.00
*14	13.00	15.03	21.00	33	32.00	34.03	40.00
*15	14.00	16.03	22.00	*34	33.00	35.03	41.00
*16	15.00	17.03	23.00	*35	34.00	36.03	42.00
*17	16.00	18.03	24.00	*36	35.00	37.03	43.00
*18	17.00	19.03	25.00	37	36.00	38.03	44.00
19	18.00	20.03	26.00	38	37.00	39.03	45.00
*20	19.00	21.03	27.00	39	38.00	40.03	46.00
21	20.00	22.03	28.00	*40	39.00	41.03	47.00
*22	21.00	23.03	29.00				

The Mark Of "\*" Are Tooled Already

**4UCON** 元化興業股份有限公司  
 4UCON TECHNOLOGY INC.

DRAWING No.		APPROVED BY		UNLESS OTHERWISE SPECIFIED TOLERANCES ARE X. ±0.50 XX ±0.20 XXX ±0.10 .XXX ±0.05 ANG. ±1°	
07621		MEI			
		CHECKED BY	HZF		
		DRAWING BY	CYP		
SCALE	NONE	REV.	A1	UNIT	mm

△ A1	Modify Data	HZF	03/01/2017
△ A0	NEW RELEASE	HZF	10/11/2015
NO. REV.	REVISIONS	CHK	DATE