

SPECIFICATIONS

Current Rating: 3 Amp/Contact Max.
 Contact Resistance: 4 Milliohms Max./Contact
 Insulation Resistance: 1000 Megohms Min. At 100V
 Operating Voltage: 60V AC/DC
 Average Insertion Force With Steel Pin Of $\phi 0.43\text{mm}$: <50g
 Average Withdrawal Force With Steel Pin Of $\phi 0.43\text{mm}$: >15g
 Mechanical Life Cycle: 200 Min.
 Operating Temperature: -40°C To $+105^{\circ}\text{C}$
 Soldering Temperature: $+260^{\circ}\text{C}$, 10s Max.
 Pin(Outer Sleeve): Brass, Machined CuZn38Pb2
 Clip(Contact 6 Finger): Beryllium Copper, Heat Treated
 Plating(Outer Sleeve): Tin Plated: 2um/80u" Ni, 5um/200u" Sn
 Plating(Contact): 2um/80u" Ni, Gold Plated
 Insulator: Glass Filled Thermoplastic Polyester, UL 94V-0, Black

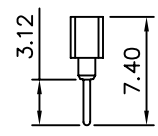
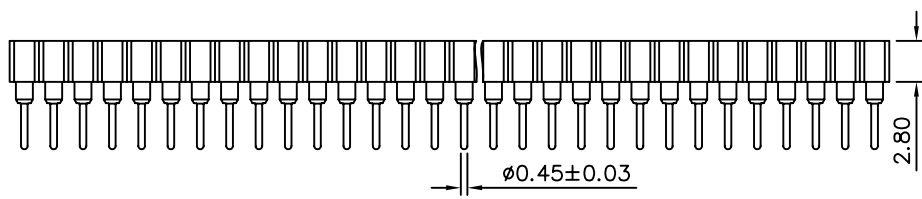
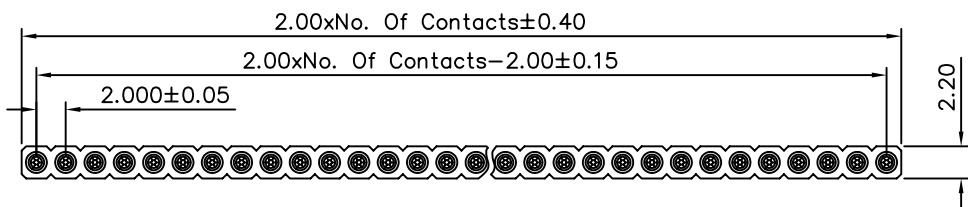
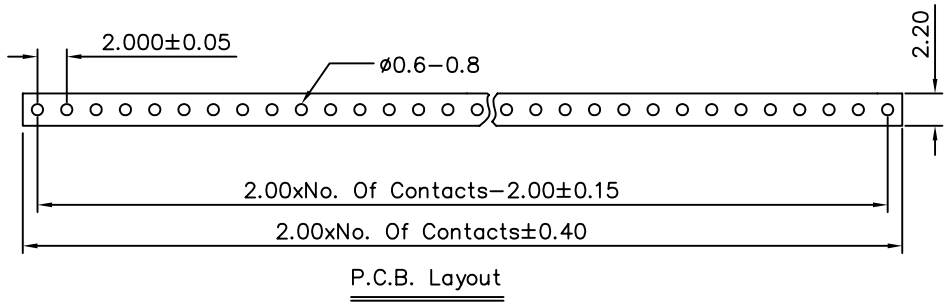

4UCON 元化興業股份有限公司
 4UCON TECHNOLOGY INC.

DRAWING No.		APPROVED BY		UNLESS OTHERWISE SPECIFIED TOLERANCES ARE X. ±0.35 .X ±0.20 .XX ±0.15 .XXX ±0.05 ANG ±5°					
07715		MEI							
		CHECKED BY							
		BECKY							
		DRAWING BY							
		HZF							
SCALE	NONE	REV.	A0	UNIT	mm	NO. REV.	REVISIONS	CHK	DATE
						A0	NEW RELEASE	BECKY	11/04/2005