

Recommended P.C.B. Layout(Component Side)

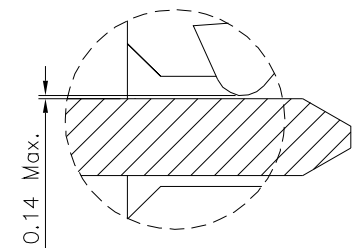

Detail X Close Type

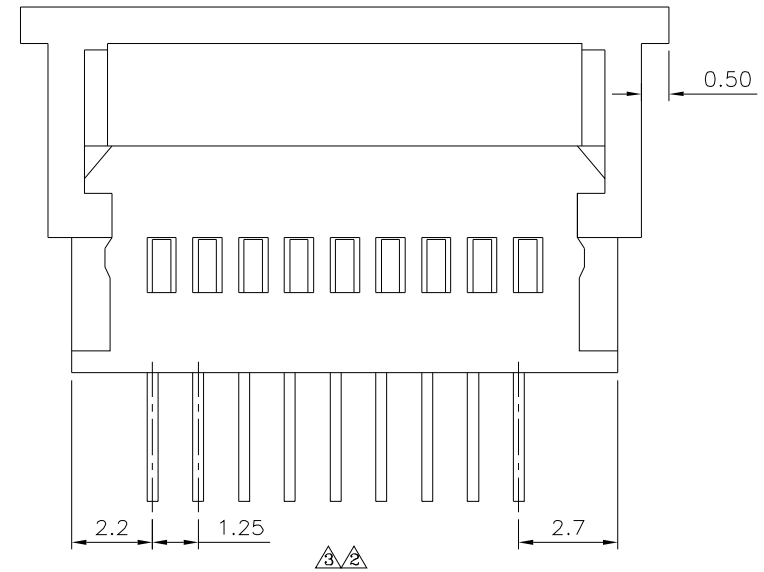
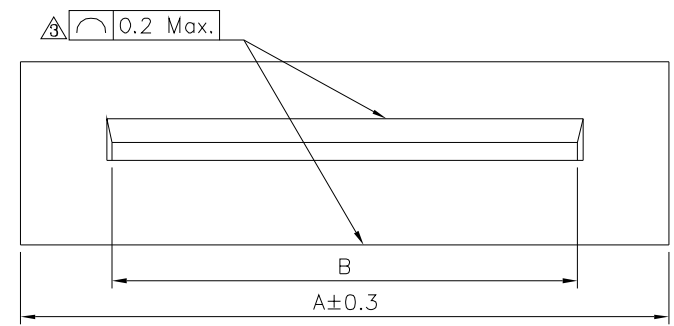
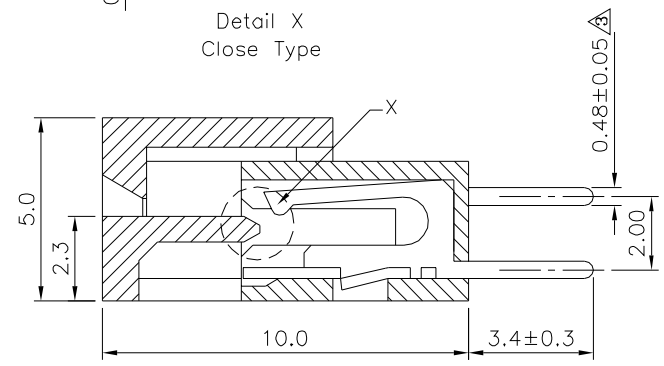

Open Type

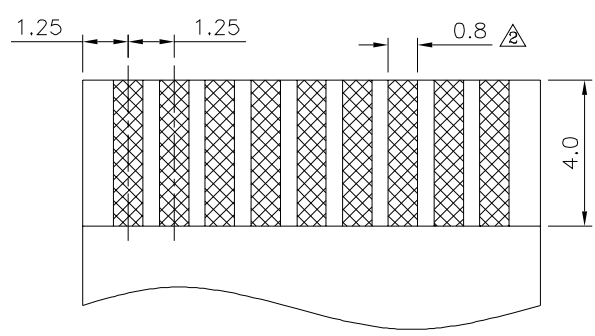

FFC/FPC Dimension
Thickness: 0.3 ± 0.05 mm

SPECIFICATION

1. General Characteristics:
1.25mm FPC XXP DIP 180° ZIF Single Contact
Reverse Layout White
2. Material & Finish:
Housing: PBT(UL94V-0), White
Terminal: Phosphor Bronze, Tin Plated Over Nickel
3. Electrical Characteristics:
Current Rating: 1 Amp AC, DC
Voltage Rating: 200V AC, DC
Contact Resistance: 20 Milliohms Max.
Insulation Resistance: 500 Megaohms Min.
4. Environmental Characteristics:
Ambient Temperature Range: $-20^{\circ}\text{C} \sim +85^{\circ}\text{C}$
5. RoHS Compliant

Pin	A	B	Pin	A	B
03	9.55	5.20	18	28.30	23.95
04	10.80	6.45	19	29.55	25.20
05	12.05	7.70	20	30.80	26.45
06	13.30	8.95	21	32.05	27.70
07	14.55	10.20	22	33.30	28.95
08	15.80	11.45	23	34.55	30.20
09	17.05	12.70	24	35.80	31.45
10	18.30	13.95	25	37.05	32.70
11	19.55	15.20	26	38.30	33.95
12	20.80	16.45	27	39.55	35.20
13	22.05	17.70	28	40.80	36.45
14	23.30	18.95	29	42.05	37.70
15	24.55	20.20	30	43.30	38.95
16	25.80	21.45	31	44.55	40.20
17	27.05	22.70	32	45.80	41.45

4UCON 元化興業股份有限公司
4UCON TECHNOLOGY INC.

DRAWING No. 08808

APPROVED BY MEI
CHECKED BY HZF
DRAWING BY CYP

UNLESS OTHERWISE SPECIFIED TOLERANCES ARE
.X ± 0.30
.XX ± 0.25
.XXX ± 0.15
ANG. $\pm 3^{\circ}$

NO.	REV.	REVISIONS	CHK	DATE
A4		Modify Data	HZF	08/08/2018
A3		Modify Data	HZF	03/25/2016
A2		Modify Data	HZF	10/08/2013
A1		Modify Data	HZF	03/26/2010
A0		NEW RELEASE	BECKY	03/02/2006

SCALE NONE REV. A4

UNIT mm

