

Recommended P.C.B. Layout

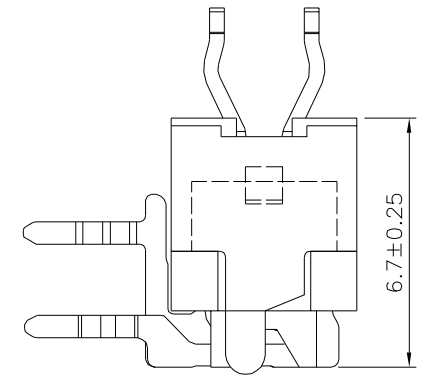

Mating Height Draw.

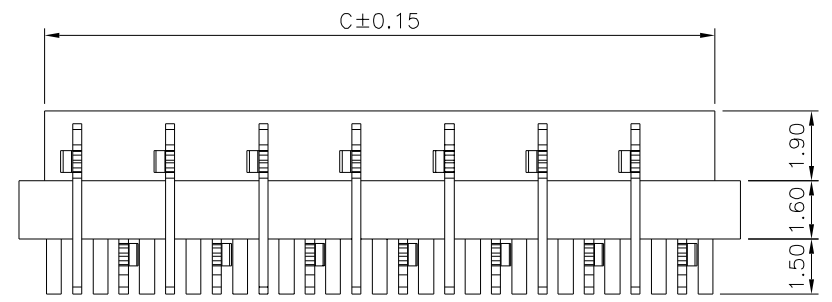
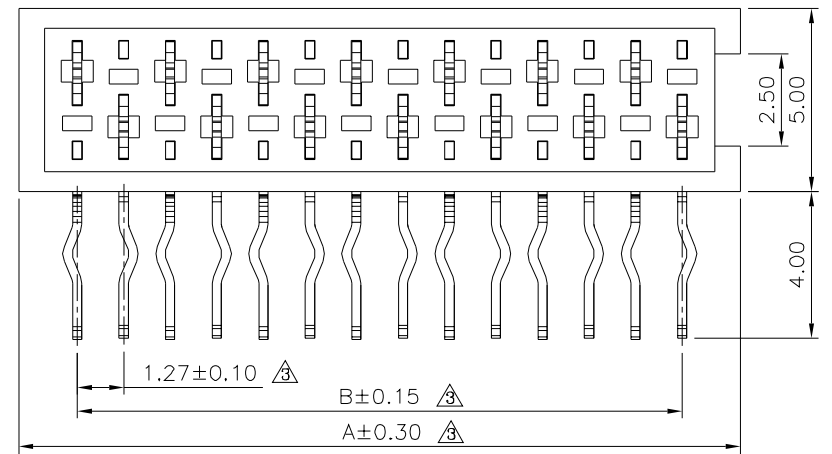
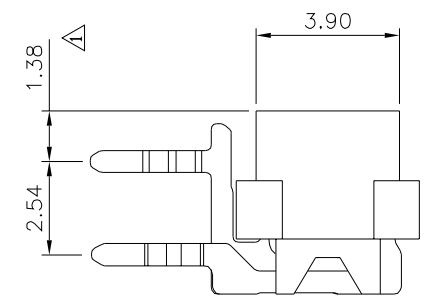

SPECIFICATION
 Current Rating:1.0A AC/DC
 Voltage Rating:30V AC/DC
 Contact Resistance:20 Milliohms Max.
 Insulation Resistance:1000 Megaohms Min.
 Withstanding Voltage:500V AC/Minute
 Operation Temperature Range:-40°C~+105°C
 Insulator:PA9T(UL94V-0),Red
 Contact:Phosphor Bronze,Tin Plated
 RoHS Compliant

Pin	A	B	C
04	7.00	3.81	5.60
06	9.54	6.35	8.14
08	12.08	8.89	10.68
10	14.62	11.43	13.22
12	17.16	13.97	15.76
14	19.70	16.51	18.30
16	22.24	19.05	20.84
18	24.78	21.59	23.38
20	27.32	24.13	25.92
22	29.86	26.67	28.46
24	32.40	29.21	31.00
26	34.94	31.75	33.54

4UCON 元化興業股份有限公司
 4UCON TECHNOLOGY INC.

DRAWING No.
 09253

APPROVED BY EMILY
 CHECKED BY HZF
 DRAWING BY WSS

UNLESS OTHERWISE SPECIFIED TOLERANCES ARE
 .X ±0.20
 .XX ±0.15
 ANG.
 UNIT mm

NO.	REV.	REVISIONS	CHK	DATE
	A3	Modify Data	HZF	02/11/2022
	A2	Modify Data	HZF	03/21/2011
	A1	Modify Data	HZF	06/09/2010
	A0	NEW RELEASE	BECKY	02/15/2005

SCALE NONE REV. A3