

Recommended P.C.B. Layout

SPECIFICATION
 Electrical Rating:UL 250V 2A,AC/DC
 CSA 250V 2A,AC/DC
 Contact:Brass,Tin Plated Over Nickel
 Base:PA66(UL94V-0),White
 RoHS Compliant

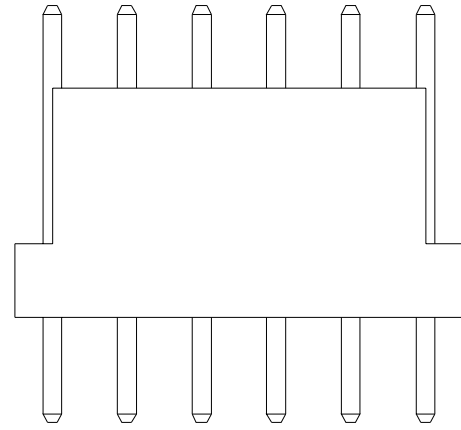
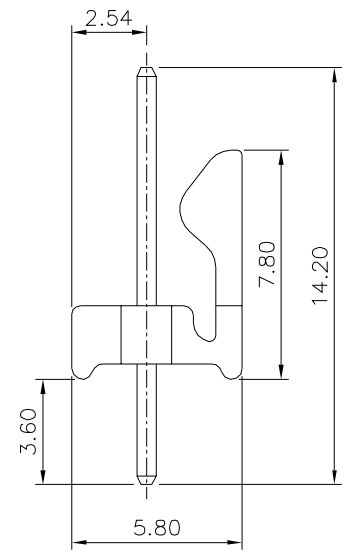
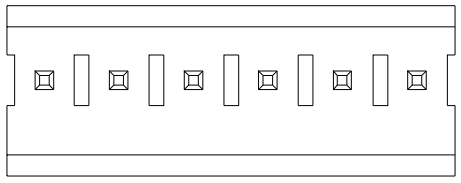
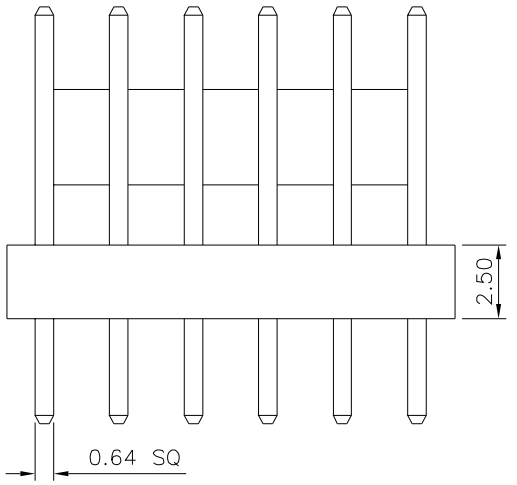
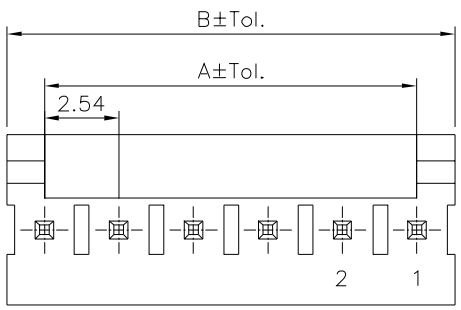

Pin	A	B	A&B Tol.
02	2.54	5.08	
03	5.08	7.62	+0.20 -0.10
04	7.62	10.16	
05	10.16	12.70	
06	12.70	15.24	
07	15.24	17.78	+0.30 -0
08	17.78	20.32	
09	20.32	22.86	
10	22.86	25.40	+0.40 -0
11	25.40	27.94	
12	27.94	30.48	
13	30.48	33.02	+0.50 -0
14	33.02	35.56	
15	35.56	38.10	
16	38.10	40.64	+0.60 -0
17	40.64	43.18	
18	43.18	45.72	
19	45.72	48.26	+0.70 -0
20	48.26	50.80	
21	50.80	53.34	
22	53.34	55.88	
23	55.88	58.42	
24	58.42	60.96	
25	60.96	63.50	
26	63.50	66.04	
27	66.04	68.58	
28	68.58	71.12	

4UCON 元化興業股份有限公司
 4UCON TECHNOLOGY INC.

DRAWING No. 09447
 APPROVED BY Jason Wu
 CHECKED BY Leo Han
 DRAWING BY Michelle Lee
 SCALE NONE REV. B0

UNLESS OTHERWISE SPECIFIED TOLERANCES ARE
 .X ±0.30
 .XX ±0.20
 .XXX ±0.10
 ANG. ±2°
 UNIT mm

NO.	REV.	DESCRIPTION	CHK	DATE
△ B0		NEW RELEASE	HZF	04/07/2026
		REVISIONS		