

SPECIFICATION
 Current Rating:2.5A AC/DC
 Voltage Rating:250V AC/DC
 Withstand Voltage:800V AC/Minute
 Insulation Resistance:1000 Megaohms Min.
 Temperature Range:-25°C~+85°C
 Insulator:PBT(UL94V-0),Black
 RoHS Compliant

Latch And Polarization RIB Location

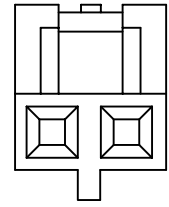

2 Circuit

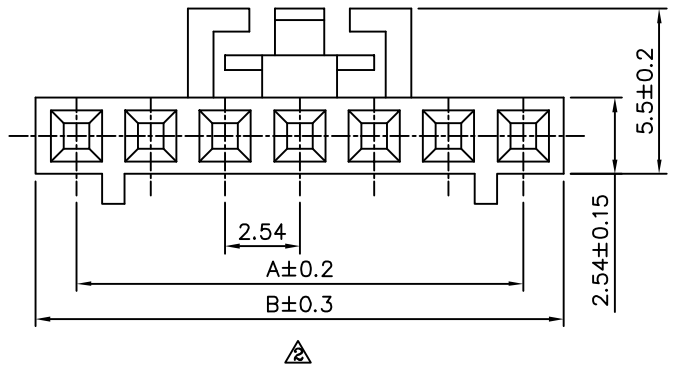
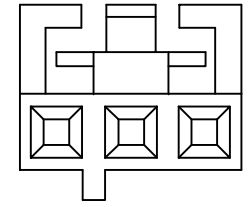

3 Circuit

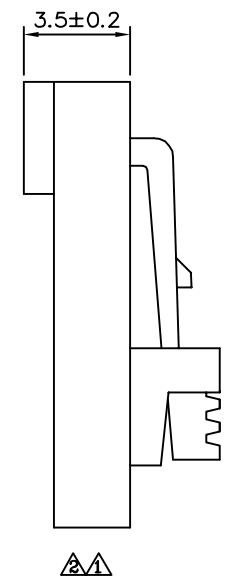
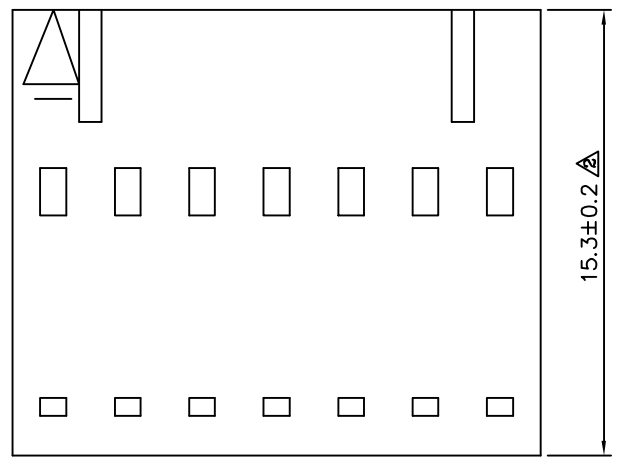

Circuits	A	B
02	2.54	5.35
03	5.08	7.89
04	7.62	10.43
05	10.16	12.97
06	12.70	15.51
07	15.24	18.05
08	17.78	20.59
09	20.32	23.13
10	22.86	25.67
11	25.40	28.21
12	27.94	30.75
13	30.48	33.29
14	33.02	35.83
15	35.54	38.37
16	38.10	40.91
17	40.64	43.45
18	43.18	45.99

4UCON 元化興業股份有限公司
 4UCON TECHNOLOGY INC.

DRAWING No.		APPROVED BY		UNLESS OTHERWISE SPECIFIED TOLERANCES ARE X _y ±0.5 XX ±0.25 XXX ±0.2 .XXX ±0.08
10084		MEI		
		CHECKED BY		
		HZF		
		DRAWING BY		
		CYP		
SCALE	NONE	REV.	B2	UNIT
				mm

NO.	REV.	REVISIONS	CHK	DATE
△B2		Modify Data	HZF	09/23/2016
△B1		Modify Data	HZF	03/03/2010
△B0		NEW RELEASE	BECKY	06/07/2006