

PCB Layout

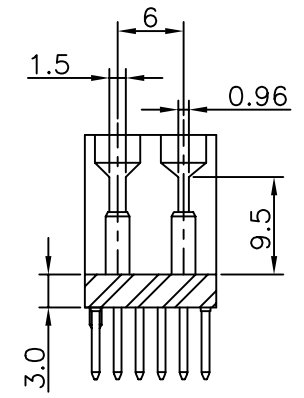

Section A-A

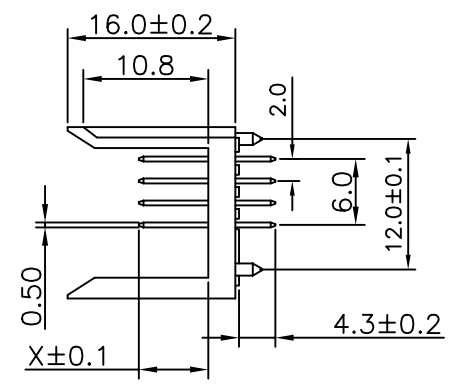
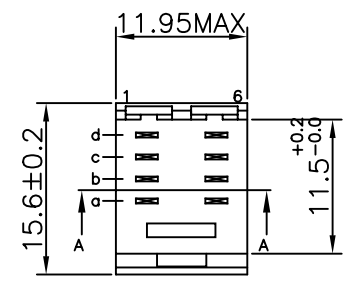
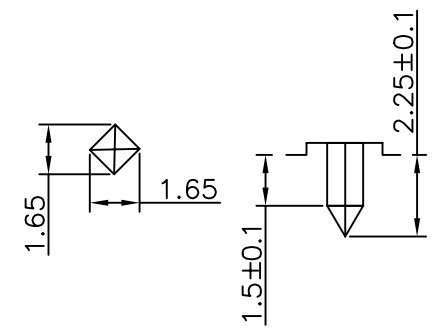
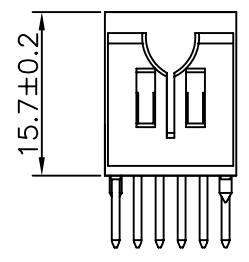

TYPE	X LENGTH
1	6.5
2	7.25
3	8.0

4UCON 元化興業股份有限公司
4UCON TECHNOLOGY INC.

DRAWING No.
10557

APPROVED BY MEI
CHECKED BY BECKY
DRAWING BY HZF

UNLESS OTHERWISE SPECIFIED TOLERANCES ARE
.X ±0.25
.XX ±0.13
.XXX
UNIT mm

SCALE NONE

REV. A0

NO. REV.

REVISIONS

MEI
CHK DATE