

Recommended P.C.B. Layout

**SPECIFICATION**

Current Rating: 10 Amp/Way Max.  
 Voltage Rating: 150V AC  
 Withstanding Voltage: 2000V AC/Minute  
 Test Time=60 Sec/1 PCS  
 Contact Resistance: 20 Milliohms Max.  
 Wire Range: 16~30 AWG  
 Torque: 2kgf.cm/M2  
 Operating Temperature: -40°C~+105°C  
 Soldering Reliability: Test Temperature=250°C±10°C  
 5 Seconds Max.  
 Terminal: Copper Alloy, Tin Plated  
 Screw: Steel, Galvanized And With Cr3+ Plated  
 Wire Guard: Stainless Steel  
 Insulator Body(Housing): Polyamide(UL94V-0), Blue  
 RoHS Compliant

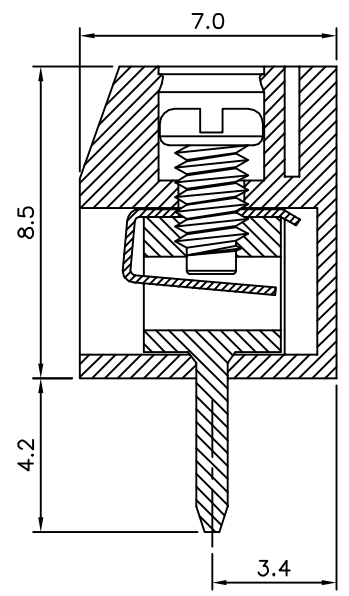
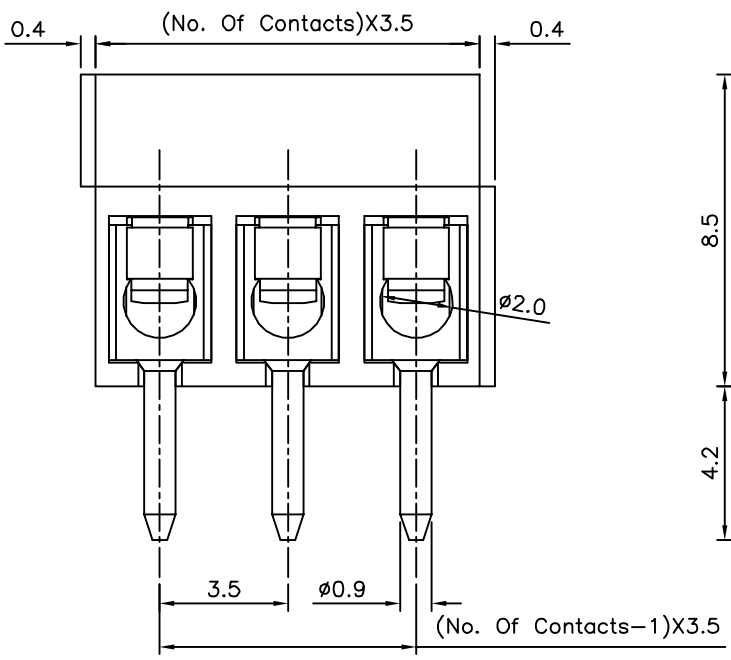

**4UCON** 元化興業股份有限公司  
 4UCON TECHNOLOGY INC.

DRAWING No.		APPROVED BY		UNLESS OTHERWISE SPECIFIED TOLERANCES ARE X. ±0.50 .X ±0.30 .XX ±0.20 ANG. ±1°
10687		EMILY		
		CHECKED BY		
		HZF		
		DRAWING BY		
		WSS		
SCALE	NONE	REV.	BO	UNIT
				mm

NO.	REV.	REVISIONS	CHK	DATE
△	BO	NEW RELEASE	HZF	10/26/2014