

SPECIFICATION
 Contact Current Rating:0.5 Amp
 Withstand Voltage:500V AC
 Contact Resistance:35 Milliohms Max.
 Insulation Resistance:>500 Megaohms Min.
 Operation Temperature:-55°C~+85°C
 Insulator:PBT(UL94V-0),Black
 Contact:Phosphor Bronze
 Selective Gold Plated 5u" Over Nickel
 Front Shell:Steel,Nickel Plated Over Copper
 Hood:PBT(UL94V-0),Black
 Jackscrews:Steel,Nickel Plated Over Copper
 Hex Nuts:Steel,Nickel Plated Over Copper
 Cable Clipper:Steel,Nickel Plated Over Copper
 Screws:Steel,Nickel Plated Over Copper
 RoHS Compliant

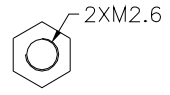
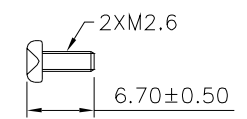
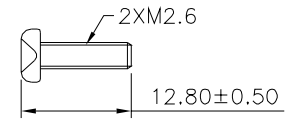
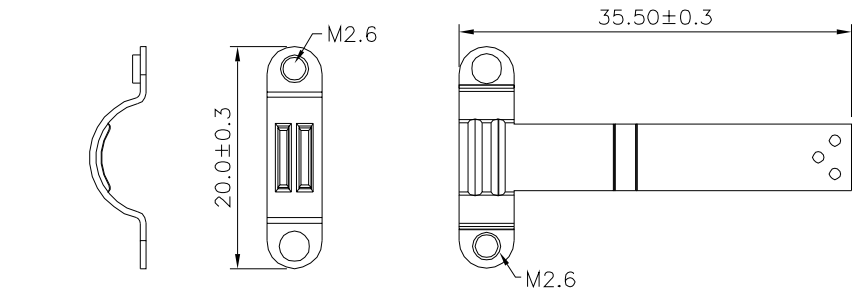
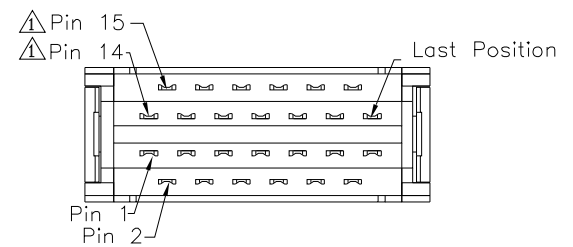
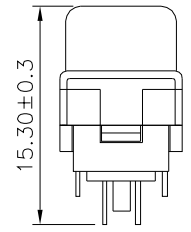
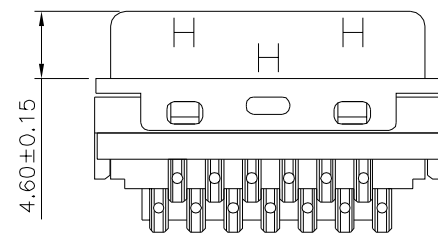
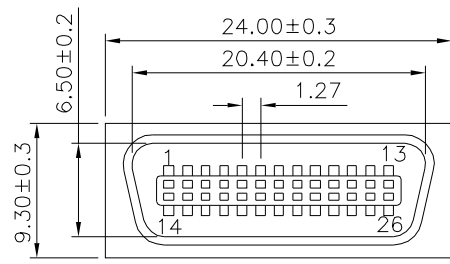
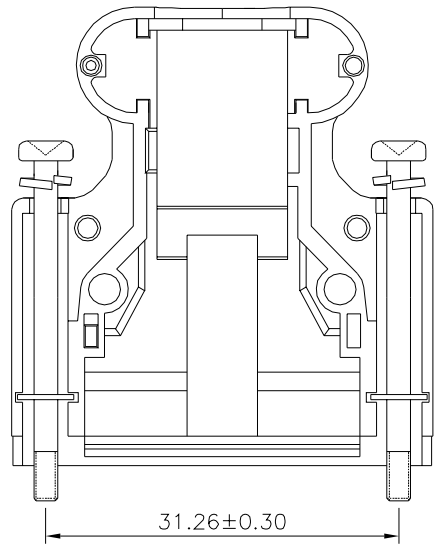
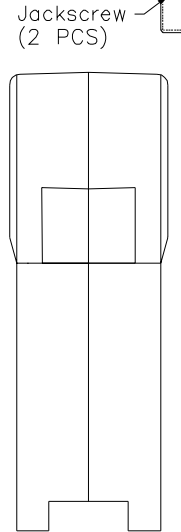
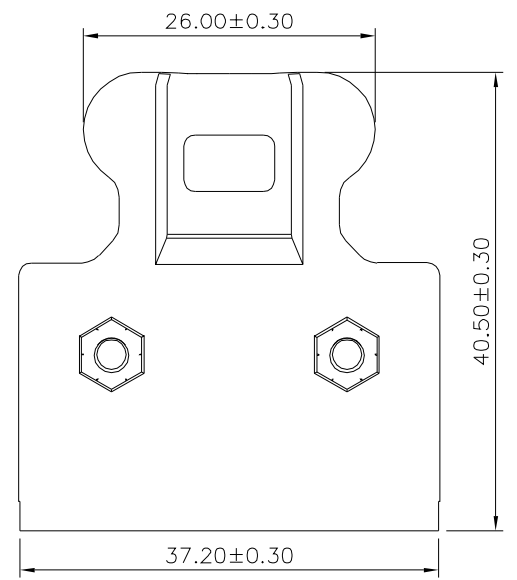
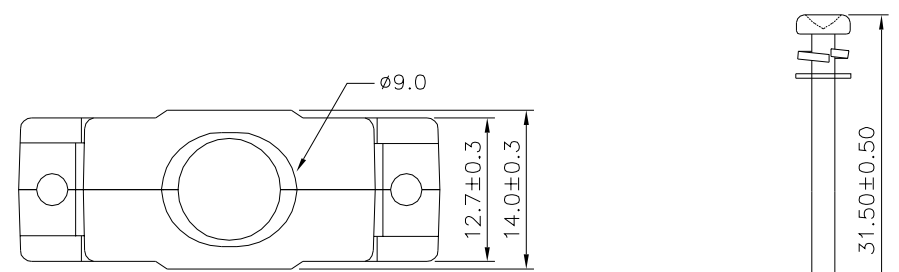

4UCON 元化興業股份有限公司
 4UCON TECHNOLOGY INC.

DRAWING No.		APPROVED BY		UNLESS OTHERWISE SPECIFIED TOLERANCES ARE .X ±0.38 .XX ±0.25 ANG.
10953		MEI		
		HZF		
		DRAWING BY		UNIT mm
		CYP		
SCALE	NONE	REV.	A1	

NO.	REV.	REVISIONS	CHK	DATE
△A1		Modify Data	HZF	05/23/2020
△A0		NEW RELEASE	HZF	08/03/2015