

Recommended P.C.B. Layout

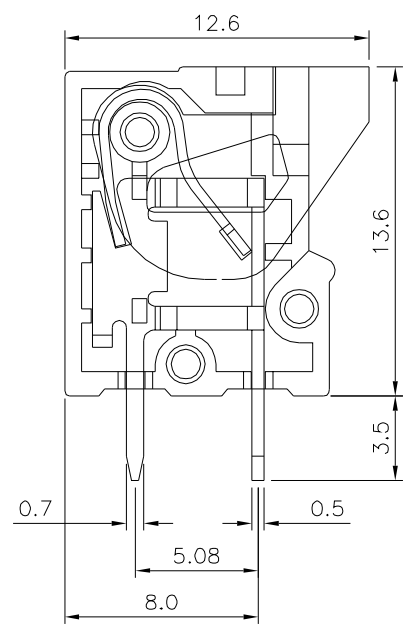
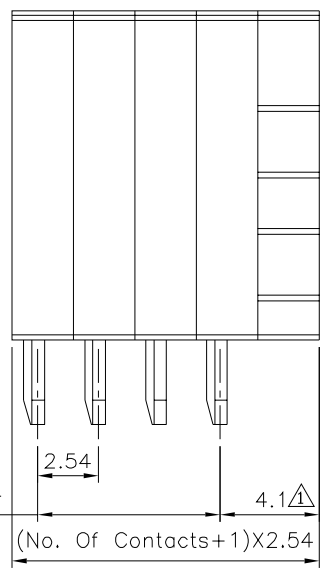

**△△△ SPECIFICATION**  
 Current Rating:2 Amp/Way Max.  
 Voltage Rating:150V AC  
 Withstanding Voltage:2000V AC(1 Minute)  
 Test Time=60s/PCS  
 Contact Resistance:20 Milliohms Max.  
 Wire Range:20~26 AWG  
 Operation Temperature:-40°C~+105°C  
 Test Temperature:250°C 5 Seconds Max.  
 Wire Guard:Stainless Steel  
 Surface Of Solder Tails:Copper Alloy,Tin Plated  
**△4 Insulator Body(Housing):Polyamide+G.F.(UL94V-0),Green RoHS Compliant**  
 \* 02~20P Available

**4UCON** 元化興業股份有限公司  
 4UCON TECHNOLOGY INC.

DRAWING No. <b>△△△</b>		APPROVED BY EMILY		UNLESS OTHERWISE SPECIFIED TOLERANCES ARE X. ±0.50 .X ±0.30 .XX ±0.20 ANG. ±1°
11400		CHECKED BY HZF		
		DRAWING BY HAO		
SCALE	NONE	REV.	A4	UNIT mm

<b>△4</b>	A4	Modify Data	HZF	06/18/2020
<b>△3</b>	A3	Modify Data	HZF	05/12/2015
<b>△2</b>	A2	Modify Data	HZF	09/10/2013
<b>△1</b>	A1	Modify Data	HZF	01/06/2012
<b>△0</b>	A0	NEW RELEASE	HZF	05/23/2009
NO.	REV.	REVISIONS	CHK	DATE