

**△ SPECIFICATION**

Voltage Rating:250V AC  
 Current Rating:10 Amp/Way Max.  
 Contact Resistance:20 Milliohms Max.  
 Insulation Resistance:5000 Megohms/1000V  
 Withstanding Voltage:1500V AC(1 Minute) Test Time=60Sec./1PCS  
 Wire Range:12~26AWG  
 Torque:4.3 kgf.cm/M3  
 Operation Temperature:-40°C~+120°C  
 Contact(Metal Housing):Copper Alloy  
 Terminal Screw:Steel,Galvanized With Cr3+ Plated  
 Wire Guard:Copper Alloy,Tin Plated  
 Insulator Body(Housing):Polyamide(Glass Filled)(UL94V-0),Green  
 RoHS Compliant

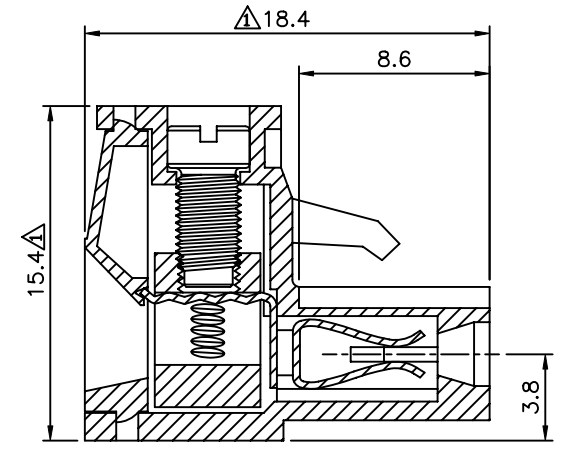
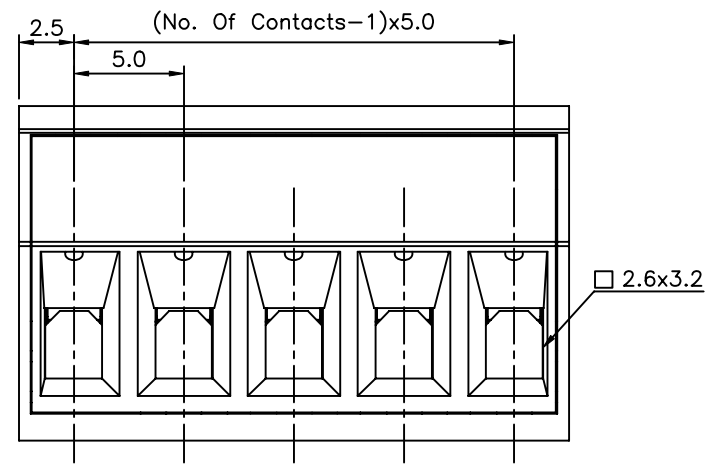
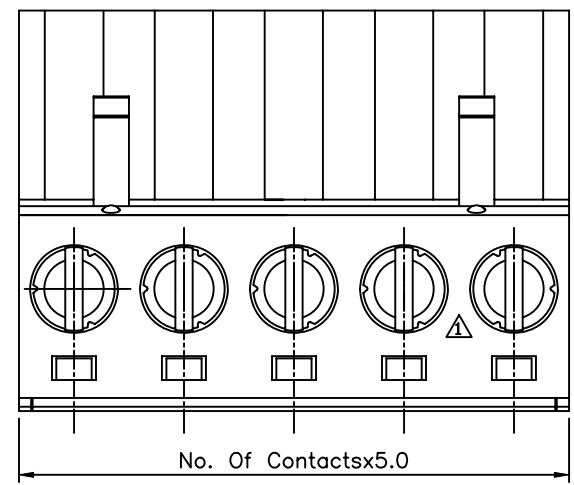

**4UCON** 元化興業股份有限公司  
 4UCON TECHNOLOGY INC.

DRAWING No.  
 11677

APPROVED BY MEI  
 CHECKED BY HZF  
 DRAWING BY WZL

UNLESS OTHERWISE SPECIFIED TOLERANCES ARE  
 X. ±0.50  
 .X ±0.30  
 .XX ±0.20  
 ANG. ±1°

SCALE NONE

REV. A1

UNIT mm

NO.	REV.	REVISIONS	CHK	DATE
△ A1		Modify Data	HZF	07/13/2010
△ A0		NEW RELEASE	HZF	05/13/2009