

△ SPECIFICATION

Voltage Rating:300V AC
 Current Rating:10 Amp/Way Max.
 Contact Resistance:20 Milliohms Max.
 Withstanding Voltage:2500V AC For 1 Minute
 Test Time=60Sec./1 PCS

Wire Range:16~30 AWG
 Torque:2 Kgf.cm/M2

△ Operation Temperature:-40°C~+105°C
 Soldering Reliability:Test Temperature=250°C±10°C
 5 Seconds Max.

Contact(Metal Housing):Copper Alloy,Nickel Plated
 Solder Pin:Copper Alloy,Tin Plated
 Terminal Screw:Steel,Galvanized,Cr3+ Plated
 Insulator Body(Housing):Polyamide(UL94V-0)
 Green

RoHS Compliant

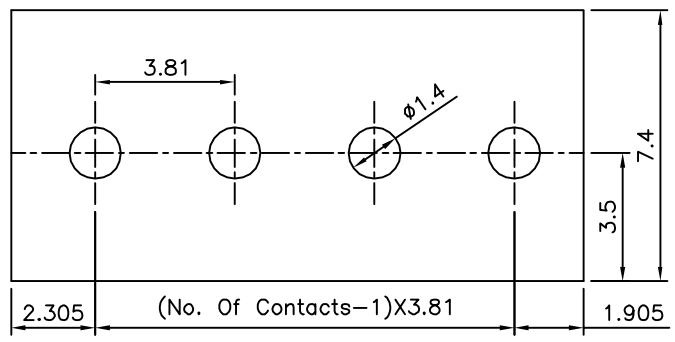
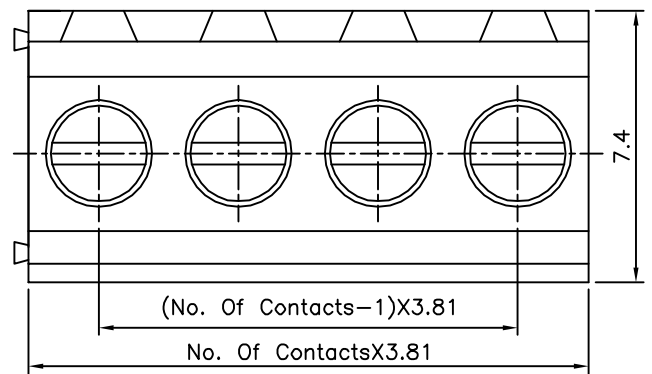

△ Recommended P.C.B. Layout

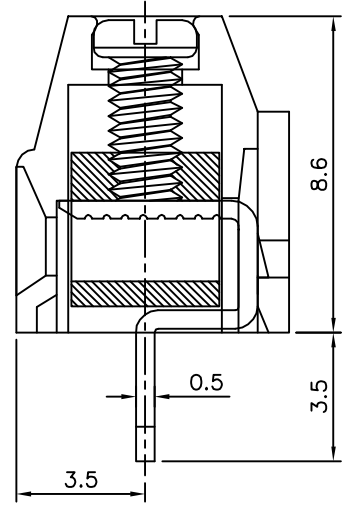
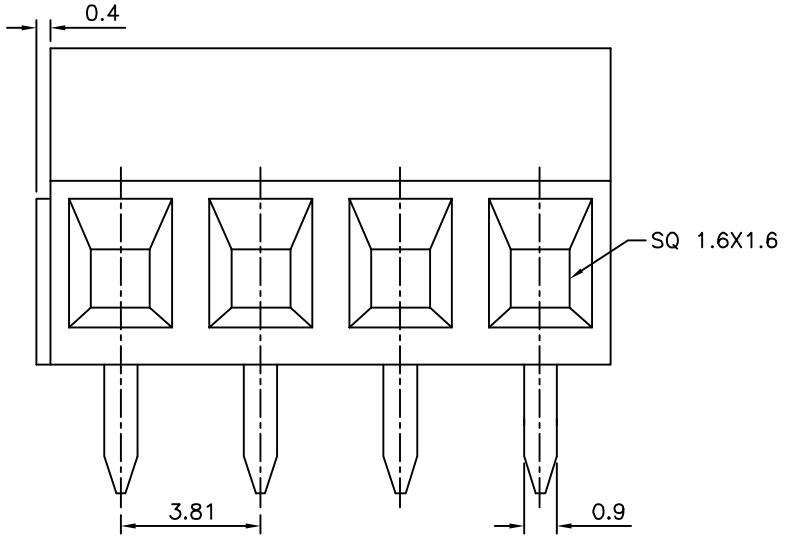

4UCON 元化興業股份有限公司
 4UCON TECHNOLOGY INC.

| | | | | |
|-------------|------|-------------|----|--|
| DRAWING No. | | APPROVED BY | | UNLESS OTHERWISE SPECIFIED TOLERANCES ARE X. ±0.50 .X ±0.30 .XX ±0.20 ANG. ±1° |
| 12342 | | EMILY | | |
| | | CHECKED BY | | |
| | | HZF | | |
| | | DRAWING BY | | UNIT mm |
| | | HAO | | |
| SCALE | NONE | REV. | A2 | |
| | | | | |

| | | | | |
|------|------|-------------|-----|------------|
| NO. | REV. | REVISIONS | CHK | DATE |
| △ A2 | | Modify Data | HZF | 11/06/2014 |
| △ A1 | | Modify Data | HZF | 07/05/2011 |
| △ A0 | | NEW RELEASE | HZF | 04/15/2010 |