

**SPECIFICATION**  
 Current Rating:3 Amps  
 ⚠ Withstanding Voltage:1000V AC  
 Contact Resistance:20 Milliohms Max.  
 Insulation Resistance:1000 Megaohms Min.  
 Operation Temperature:-40°C~+105°C  
 Housing:PA6T(UL94V-0),Black  
 ⚠ Contact:Phosphor Bronze,Gold Flash Over Nickel  
 RoHS Compliant

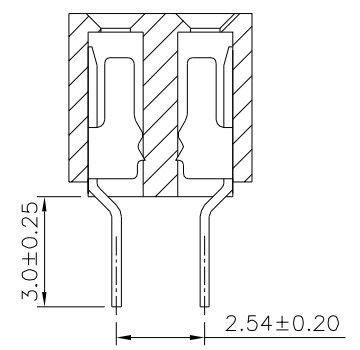
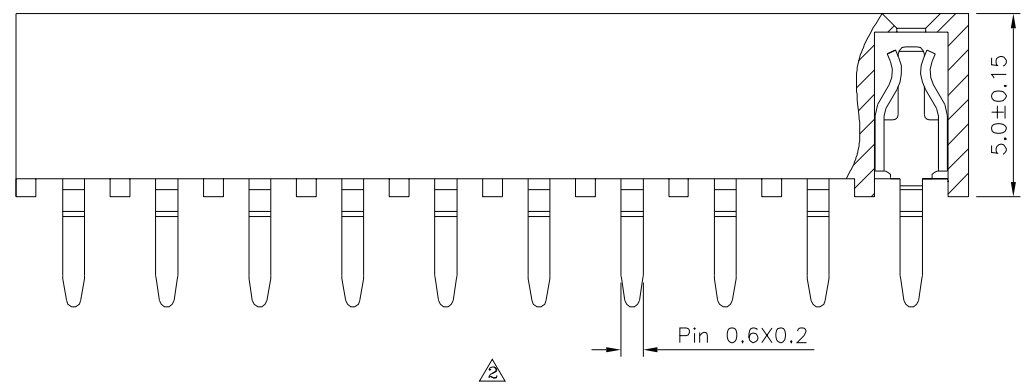
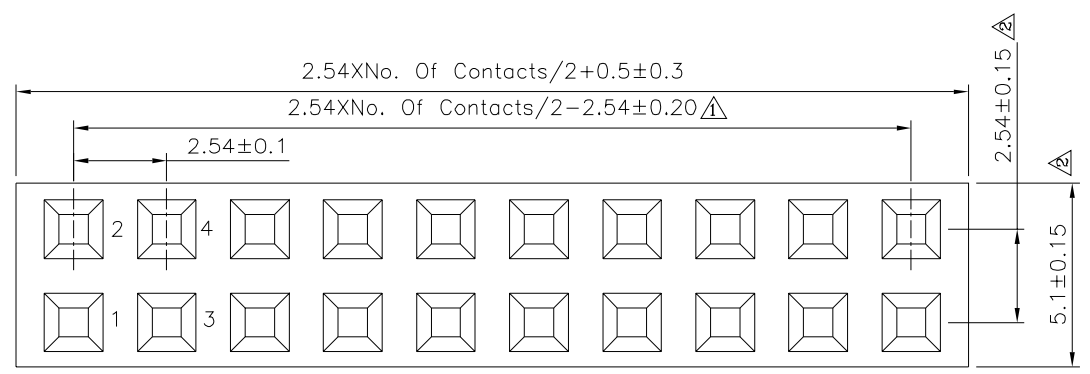
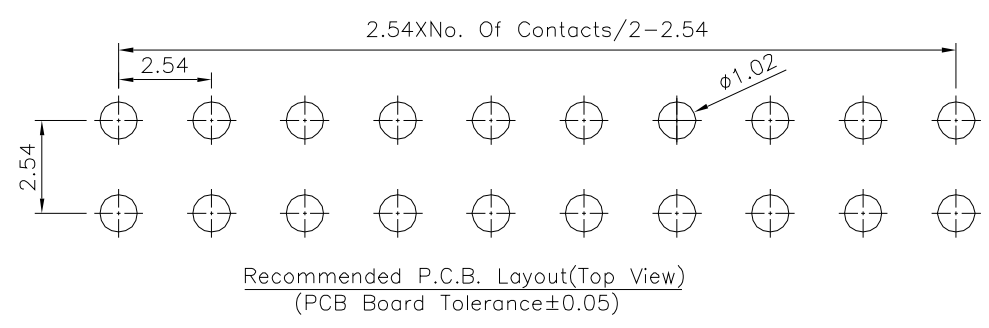

**4UCON** 元化興業股份有限公司  
 4UCON TECHNOLOGY INC.

DRAWING No.		APPROVED BY		UNLESS OTHERWISE SPECIFIED TOLERANCES ARE X. ±0.25 X.* ±2" .X ±0.20 .X* ±1.5" .XX ±0.15 .XX* ±1" .XXX ±0.10 .XXX* ±0.5"
12785		MEI		
		CHECKED BY HZF		
		DRAWING BY CYP		
SCALE	NONE	REV.	A2	UNIT mm

NO.	REV.	REVISIONS	CHK	DATE
⚠	A2	Modify Data	HZF	08/13/2019
⚠	A1	Modify Data	HZF	04/21/2015
⚠	A0	NEW RELEASE	HZF	07/03/2013