

**SPECIFICATION**  
 Current Rating:10A  
 Voltage Rating:250V AC  
 Insulation Resistance:500 Megohms  
 At DC 500V  
 Withstanding Voltage:AC 1500V(1 Minute)  
 Using Temperature Range:-40°C To +105°C  
 Soldering Temperature:250°C,5 Seconds Max.  
 Solder Pin:Copper Alloy,Tin Plated  
 Insulator Body(Housing):Polyamide  
 Glass Filled(UL94V-0),Green  
 RoHS Compliant

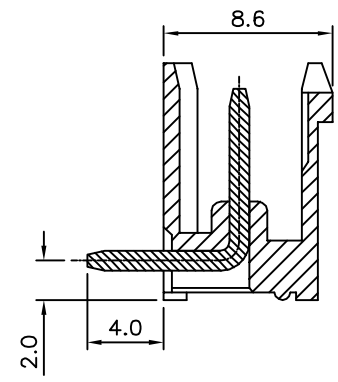
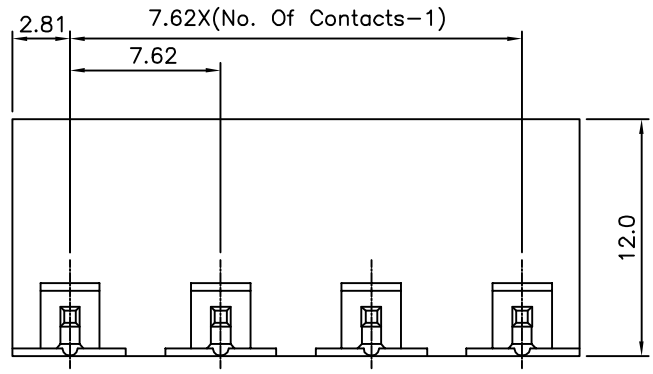
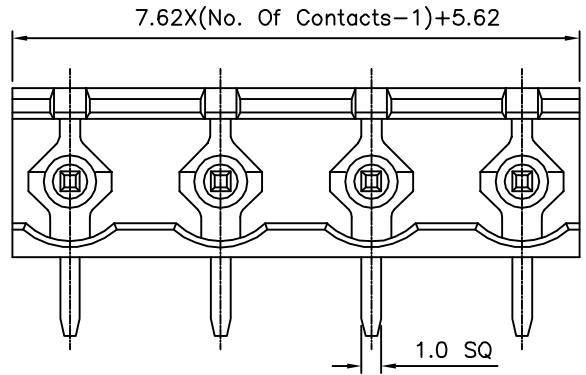
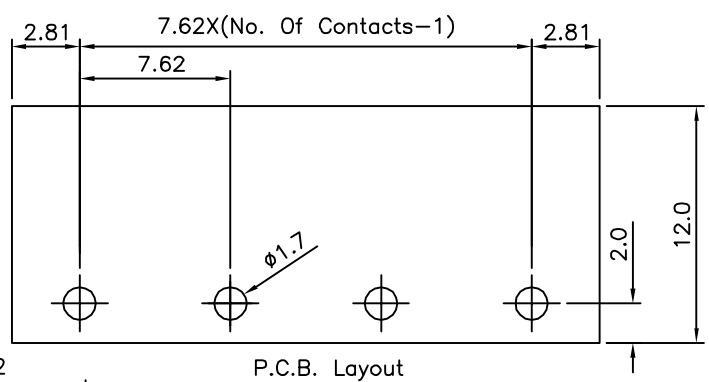

**4UCON** 元化興業股份有限公司  
 4UCON TECHNOLOGY INC.

DRAWING No.		APPROVED BY		UNLESS OTHERWISE SPECIFIED TOLERANCES ARE X. ±0.30 .X ±0.15 .XX ±0.05 ANG. ±1°
13912		MEI		
		CHECKED BY		
		HZF		
		DRAWING BY		
		XYH		
SCALE	NONE	REV.	A0	UNIT
				mm

NO.	REV.	REVISIONS	CHK	DATE
△ A0		NEW RELEASE	HZF	03/10/2010