

△

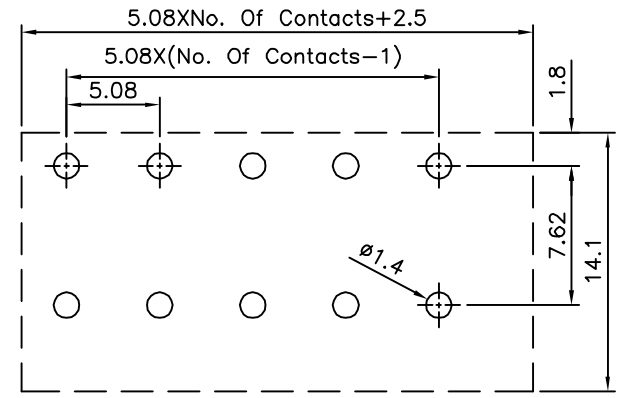

△ Recommended P.C.B. Layout

△ SPECIFICATION

Current Rating:10 Amp/Way Max.
 Voltage Rating:300V AC
 Withstanding Voltage:2500V AC For 1 Minute
 Test Time=60s/1 PCS
 Contact Resistance:20 Milliohms Max.
 Wire Range:14~22 AWG
 Operating Temperature:-40°C~+105°C
 Soldering Reliability:Test Temperature=250°C±10°C
 5 Seconds Max.
 Contact:Copper Alloy,Tin Plated
 Wire Guard:Stainless Steel
 Insulator Body:Polyamide+G.F.(UL94V-0),Green
 RoHS Compliant

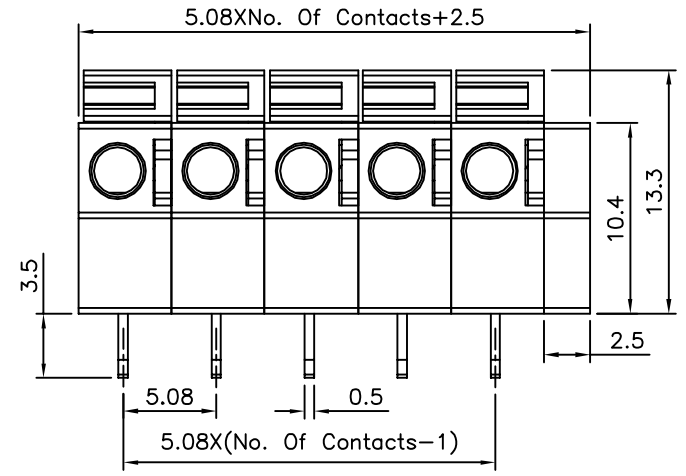

△

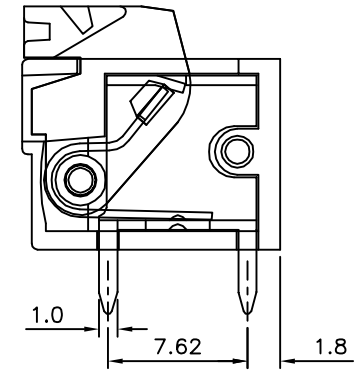

△

4UCON 元化興業股份有限公司
 4UCON TECHNOLOGY INC.

DRAWING No.		APPROVED BY		UNLESS OTHERWISE SPECIFIED TOLERANCES ARE X. ±0.50 .X ±0.30 .XX ±0.20 ANG. ±1°
14338		MEI		
		CHECKED BY HZF		
		DRAWING BY GAO		
SCALE	NONE	REV.	A1	UNIT mm

NO.	REV.	REVISIONS	CHK	DATE
△ A1		Modify Data	HZF	07/03/2013
△ A0		NEW RELEASE	HZF	02/10/2010