

△ SPECIFICATION
 Current Rating:12 Amp/Way Max.
 Voltage Rating:300V AC
 Withstanding Voltage:2500V AC/Minute
 Test Time=60 Sec./1PCS
 Contact Resistance:20 Milliohms Max.
 Wire Range:16~24 AWG
 Torque:2.5 Kgf.cm/M2
 Operation Temperature:-40°C~+105°C
△ Soldering Reliability:
 Test Temperature=250°C±10°C/5 Seconds Max.
 Contact(Metal Housing):Copper Alloy,Nickel Plated
 Terminal Screw:Steel,Galvanze With Cr3+ Plated
△ Wire Guard:Phosphor Bronze,Tin Plated
 Insulator Body(Housing):Polyamide(UL94V-0),Green
 RoHS Compliant

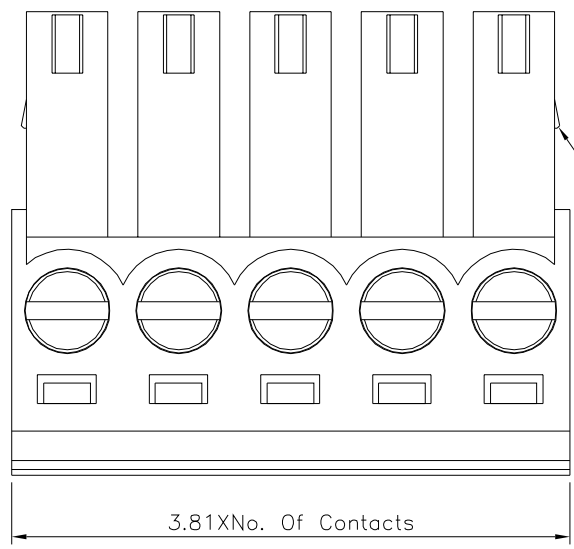

2P~6P With Wedge,Above 7P
 Without Wedge(Including 7P)

△ Above 10P Tolerance Is ± 0.8
 -0.3

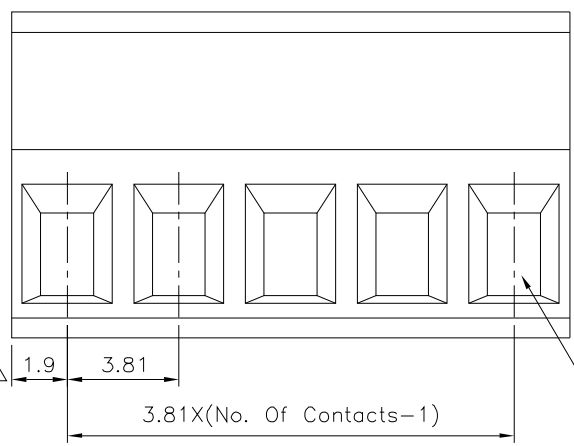

△ 1.9 3.81
 3.81X(No. Of Contacts-1)
 1.8X2.8

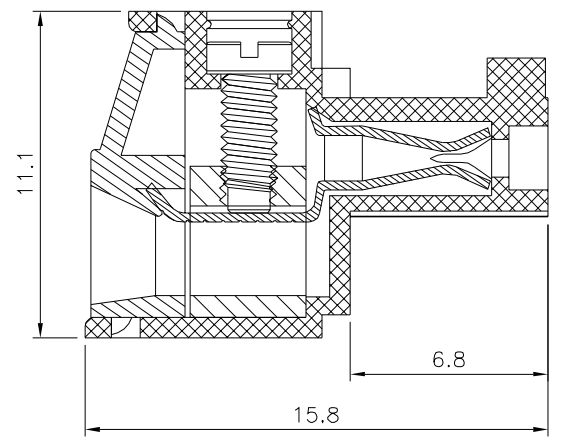

4UCON 元化興業股份有限公司
 4UCON TECHNOLOGY INC.

DRAWING No. △△△		APPROVED BY MEI		UNLESS OTHERWISE SPECIFIED TOLERANCES ARE X. ±0.50 .X ±0.30 .XX ±0.20 ANG. ±1°
15713		CHECKED BY HZF		
		DRAWING BY CYP		
SCALE	NONE	REV.	A3	UNIT mm

NO.	REV.	REVISIONS	CHK	DATE
△A3		Modify Data	HZF	01/30/2016
△A2		Modify Data	HZF	10/25/2014
△A1		Modify Data	HZF	08/14/2012
△A0		NEW RELEASE	HZF	04/10/2009