

△ SPECIFICATION
 Current Rating:0.5 Amp
 Dielectric Withstanding Voltage:500V AC
 Contact Resistance:35 Milliohms Max.
 Insulation Resistance:>500 Megaohms Min.
 Operation Temperature:-55°C~+85°C
 Insulator:PBT(UL94V-0),Black
 Contact:Phosphor Bronze,Selective Gold Plated
 5u" Over Nickel
 Front Shell:Steel,Nickel Plated Over Copper
 △ Hood/Latch Cover:ABS(UL94V-0)
 06087 :Beige Color
 15793 :Black Color
 Latch:Stainless Steel
 Inner Shell:Steel,Nickel Plated Over Copper

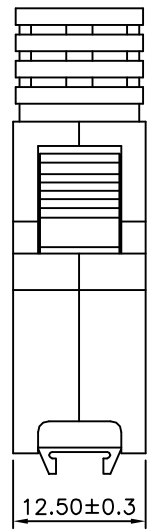

Flag Hooks

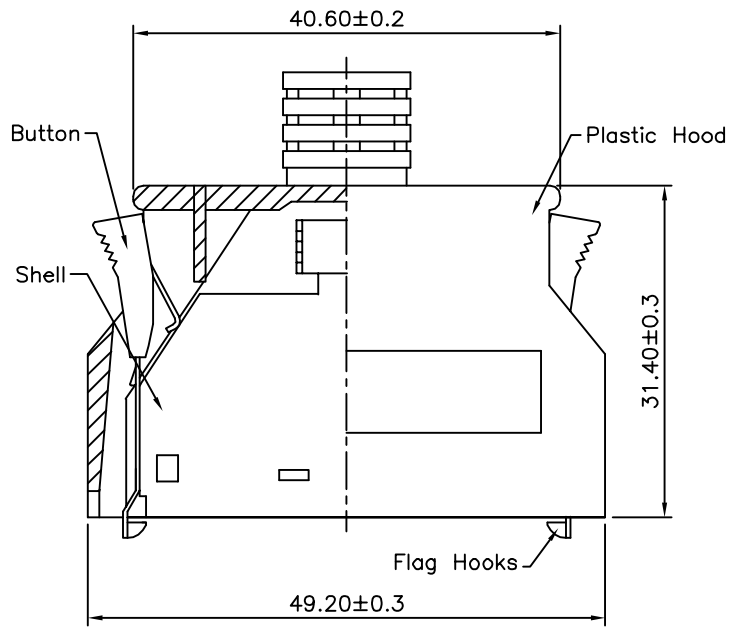
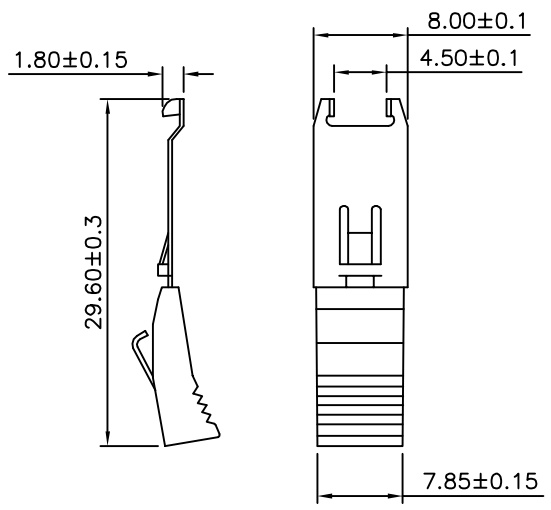
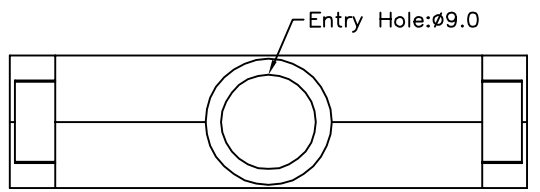
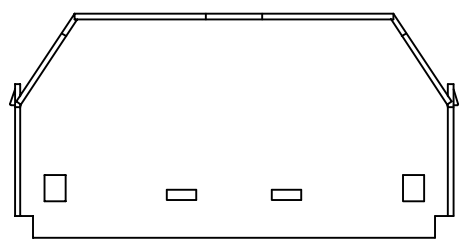
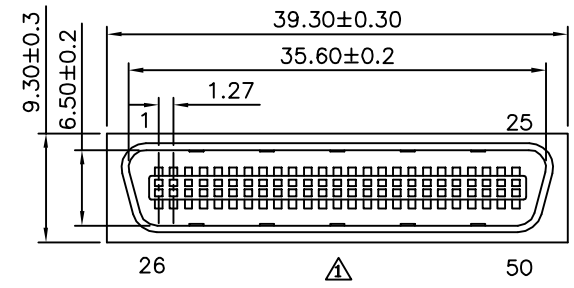

△△ Upper Cover

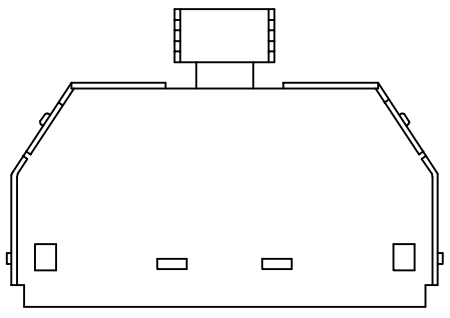

△ Lower Cover

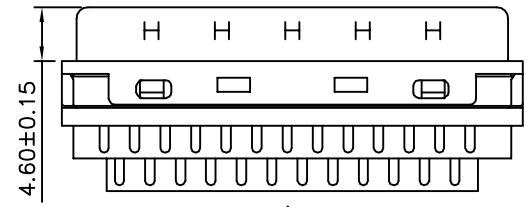

△

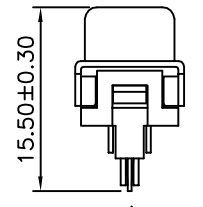

△

4UCON 元化興業股份有限公司
 4UCON TECHNOLOGY INC.

DRAWING No.		APPROVED BY		UNLESS OTHERWISE SPECIFIED TOLERANCES ARE .X ±0.38 .XX ±0.25 ANG.
15793		MEI		
		CHECKED BY	HZF	
		DRAWING BY	HAO	
SCALE	NONE	REV.	B3	UNIT mm

NO.	REV.	REVISIONS	CHK	DATE
△	B3	Modify Data	HZF	09/05/2015
△	B2	Modify Data	HZF	03/06/2013
△	B1	Modify Data	HZF	12/06/2012
△	B0	NEW RELEASE	HZF	12/02/2009