

SPECIFICATION
 Current:3A
 Contact Resistance:20 Milliohms Max.
 Insulation Resistance:1000 Megaohms Min.
 Withstanding Voltage:1000V AC RMS
 Operation Temperature:-55°C~+105°C
 Housing:PA6T(UL94V-0),Black
 Contact:Brass,Gold Flash Over Nickel
 No. Of Contacts:02~40 Contacts
 RoHS Compliant

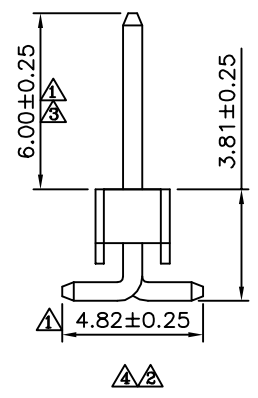
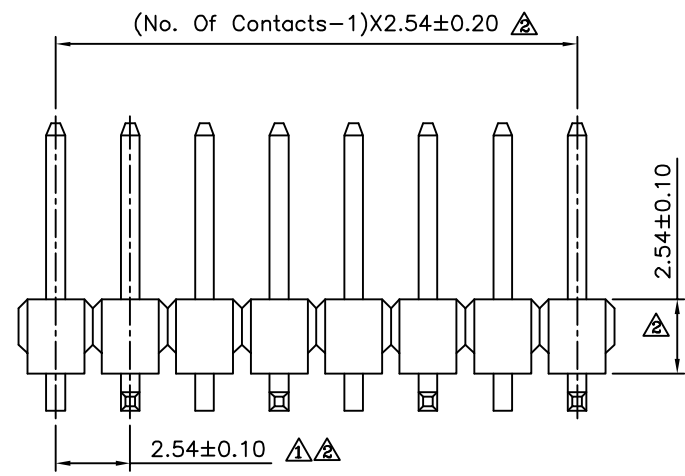
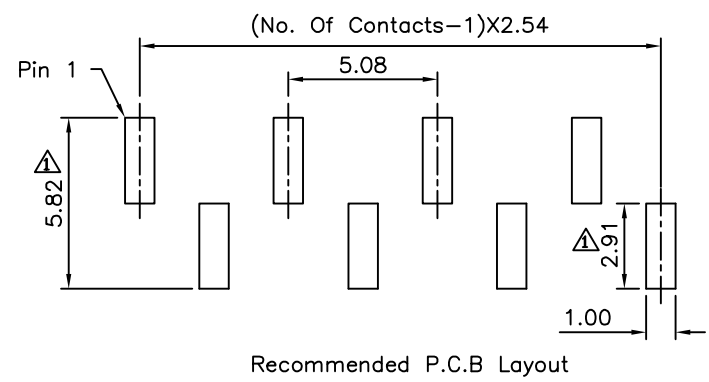
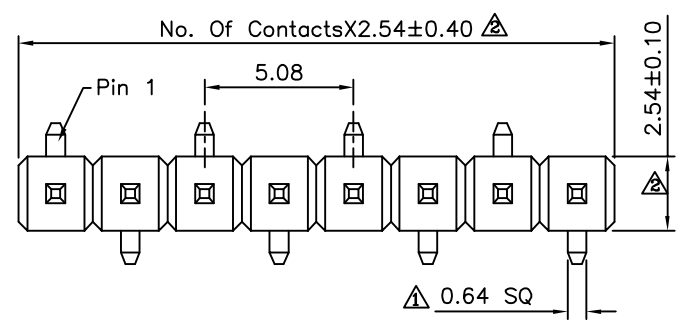

4UCON 元化興業股份有限公司
 4UCON TECHNOLOGY INC.

DRAWING No.		APPROVED BY		UNLESS OTHERWISE SPECIFIED TOLERANCES ARE .X ±0.38 .XX ±0.25 ANG ±5°
15930		EMILY		
		HZF		
		DRAWING BY		UNIT mm
		SONG		
SCALE	NONE	REV.	A4	

NO.	REV.	REVISIONS	CHK	DATE
A4		Modify Data	HZF	05/13/2013
A3		Modify Data	HZF	12/02/2011
A2		Modify Data	HZF	07/20/2011
A1		Modify Data	HZF	07/21/2009
A0		NEW RELEASE	BECKY	10/14/2004