

1.27X(No. Of Contacts/2-1)
 1.27X(No. Of Contacts/2-2)

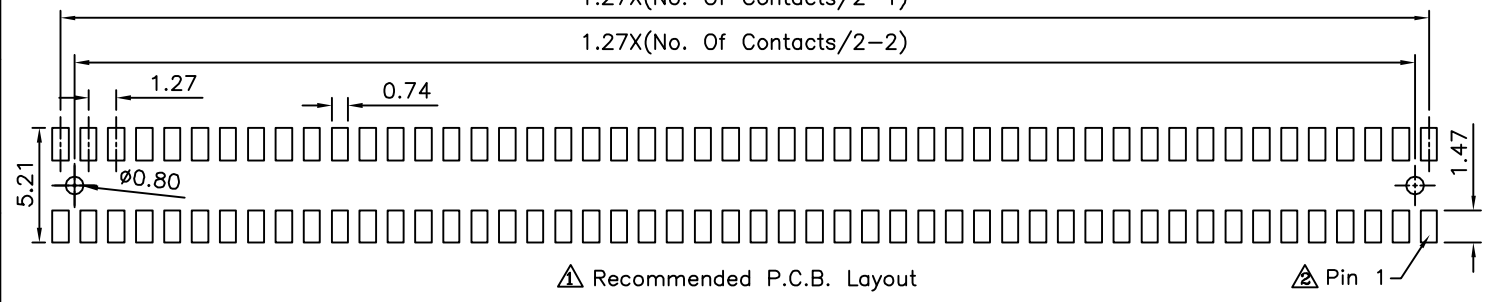

△ SPECIFICATION
 Current Rating:1 Amps
 Dielectric Withstanding:500V AC
 Insulation Resistance:5000 Megaohms Min.
 Operation Temperature:-40°C~+105°C
 Max. Processing Temperature:230°C For 30~60s
 (260°C For 10 Seconds)
 Housing:LCP(UL94V-0),Black
 Contact:Phosphor Bronze,Gold Flash Over Nickel
 RoHS Compliant

1.27XNo. Of Contacts/2+0.38
 1.27X(No. Of Contacts/2-1)

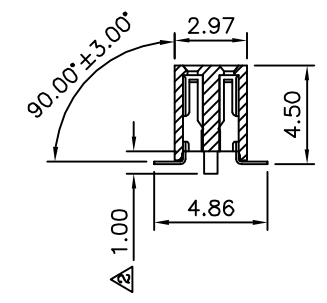
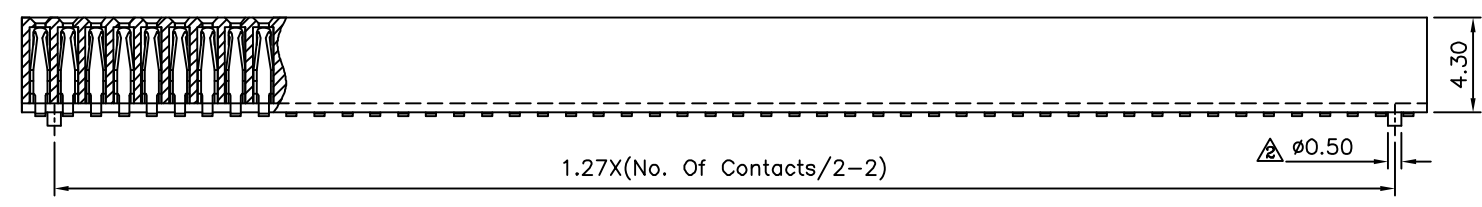
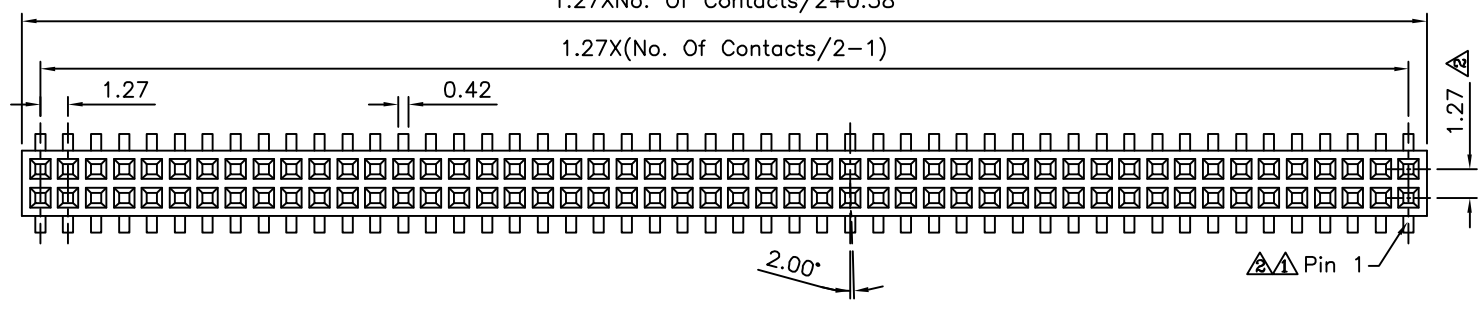

4UCON 元化興業股份有限公司
 4UCON TECHNOLOGY INC.

DRAWING No.		APPROVED BY		UNLESS OTHERWISE SPECIFIED TOLERANCES ARE X. ±0.20 .X ±0.15 .XX ±0.10 .XXX ±0.05
18400		EMILY		
		CHECKED BY HZF		
		DRAWING BY SONG		UNIT mm
SCALE	NONE	REV.	A2	

NO.	REV.	REVISIONS	CHK	DATE
△ A2		Modify Data	HZF	12/03/2013
△ A1		Modify Data	HZF	04/30/2010
△ A0		NEW RELEASE	SHIN	11/28/2006