

SPECIFICATION

- 1. General Characteristics:
0.5mm Board To Board Double Slot Type Female XXP
SMT 180° With Post Stacking Height=5.5/6.0mm
With Cap
- 2. Material & Finish:
Housing: LCP(UL94V-0), White
Contact: Phosphor Bronze, Gold Plated Over Nickel
- 3. Electrical Characteristics:
Current Rating: 0.5A AC/DC
Voltage Rating: 50V AC/DC
Contact Resistance: 30 Milliohms Max.
Insulation Resistance: 100 Megaohms Min. At 100V DC
Withstanding Voltage: 100V AC For One Minute
- 4. Environmental Characteristics:
Operation Temperature Range: -20°C ~ +105°C
- 5. RoHS Compliant

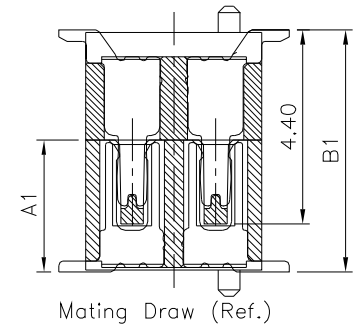
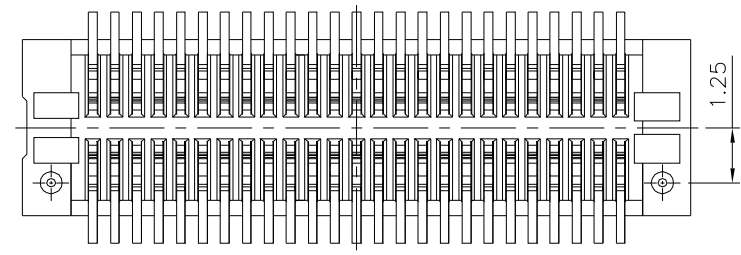
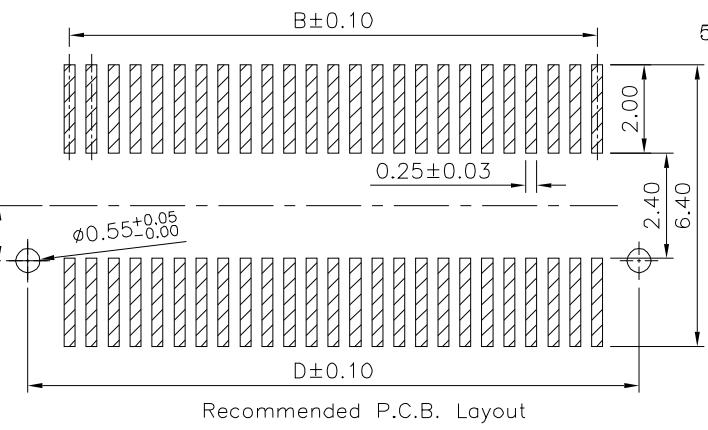
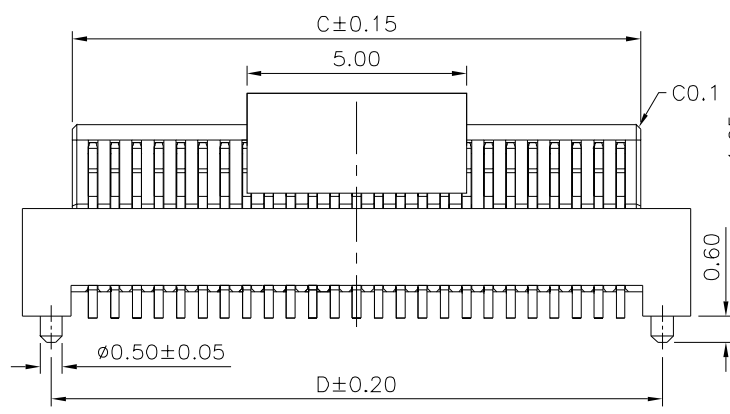

Pin	A	B	C	D
10	5.20	2.00	2.92	3.90
14	6.20	3.00	3.92	4.90
20	7.70	4.50	5.42	6.40
30	10.20	7.00	7.92	8.90
40	12.70	9.50	10.42	11.40
50	15.20	12.00	12.92	13.90
60	17.70	14.50	15.42	16.40
70	20.20	17.00	17.92	18.90
80	22.70	19.50	20.42	21.40
90	25.20	22.00	22.92	23.90
100	27.70	24.50	25.42	26.40
120	32.70	29.50	30.42	31.40

Part No.(Socket)	Part No.(Plug)	Dim. A1	Dim. B1
1660	1659	3.00	5.5
1660	1661	3.50	6.0

4UCON 元化興業股份有限公司
4UCON TECHNOLOGY INC.

DRAWING No. 19007

APPROVED BY MEI
CHECKED BY HZF
DRAWING BY CYP

UNLESS OTHERWISE SPECIFIED TOLERANCES ARE
.X ±0.2
.XX ±0.15
ANG.

SCALE NONE

REV. BO

UNIT mm

△ BO	NEW RELEASE	HZF	10/08/2024
NO. REV.	REVISIONS	CHK	DATE