

SPECIFICATION

Current Rating:3 A AC/DC
 Voltage Rating:250V AC Max.
 Dielectric Withstanding Voltage:1500V AC/Minute
 Contact Resistance:10 Milliohms Max.
 Insulation Resistance:1000 Megaohms Min.
 Operating Temperature:-25°C~+85°C
 Insulator:PA66 UL94V-2,Natural
 Terminal:Brass,Tin Plated
 RoHS Compliant

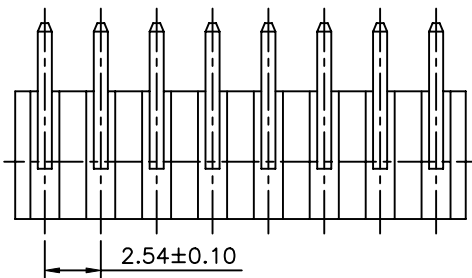
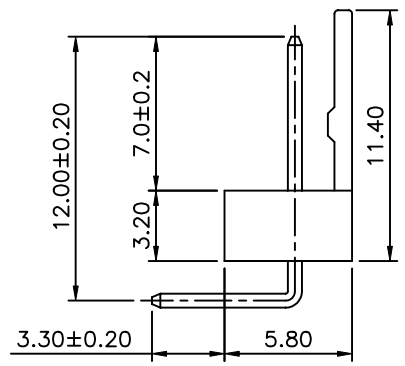
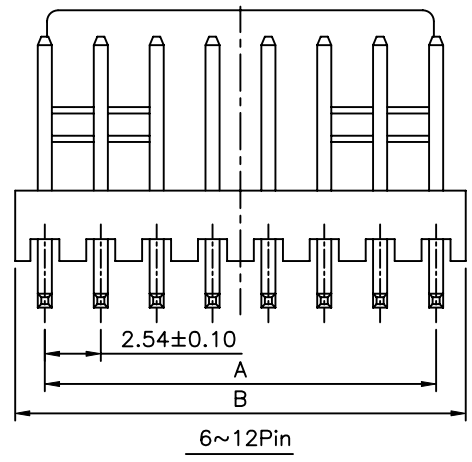
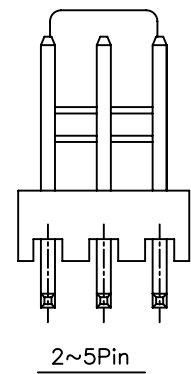
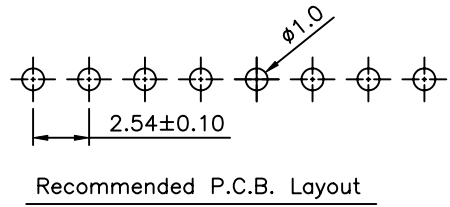
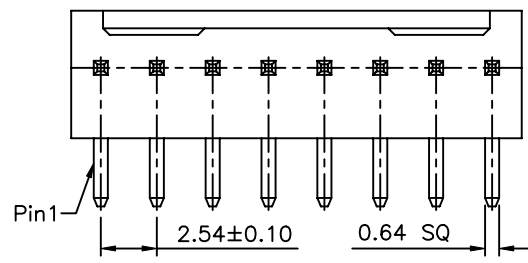
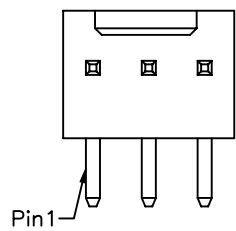

Pin	A	B	Tolerance
2	2.54	5.12	±0.20
3	5.08	7.66	
4	7.62	10.20	
5	10.16	12.74	
6	12.70	15.30	
7	15.24	17.94	±0.30
8	17.78	20.48	
9	20.32	23.02	
10	22.86	25.58	
11	25.40	28.12	
12	27.94	30.68	

4UCON 元化興業股份有限公司
 4UCON TECHNOLOGY INC.

DRAWING No.
 19172

APPROVED BY
 MEI
 CHECKED BY
 HZF
 DRAWING BY
 WZL

UNLESS OTHERWISE SPECIFIED TOLERANCES ARE
 .X ±0.35
 .XX ±0.25

SCALE NONE

REV. BO

UNIT mm

NO. REV. BO NEW RELEASE HZF 11/24/2009
 REVISIONS CHK DATE