

**SPECIFICATION**

Voltage Rating:300V AC  
 Current Rating:10A/Way Max.  
 Contact Resistance:20 Milliohms Max.  
 Withstanding Voltage:2500V AC For 1 Minute  
 Test Time=60 Sec./1 Pcs  
 Wire Range:16~30AWG  
 Torque:2 Kgf.cm/M2  
 Operation Temperature:-40°C~+105°C  
 Soldering Reliability:Test Temperature=250°C±10°C  
 5 Seconds Max.  
 Contact(Metal Housing):Copper Alloy,Nickel Plated  
 Solder Pin:Copper Alloy,Tin Plated  
 Terminal Screw:Steel,Galvanized With Cr3+ Plated  
 Insulator Body(Housing):Polyamide(UL94V-0),Green  
 RoHS Compliant

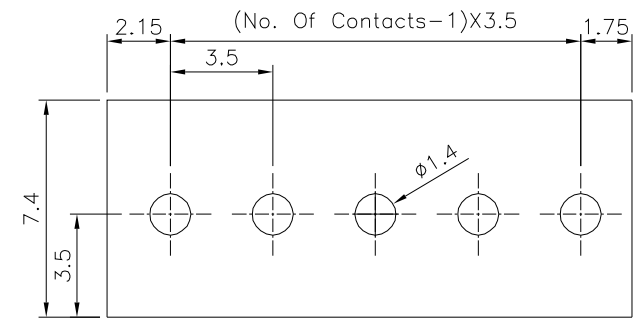

Recommended P.C.B. Layout

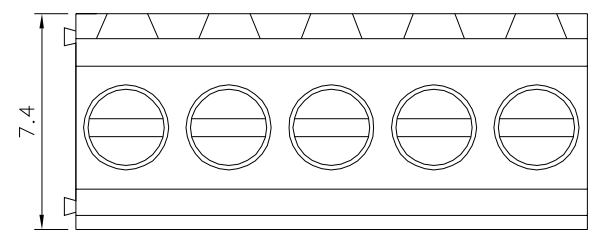
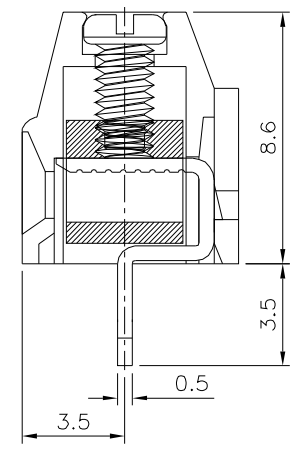
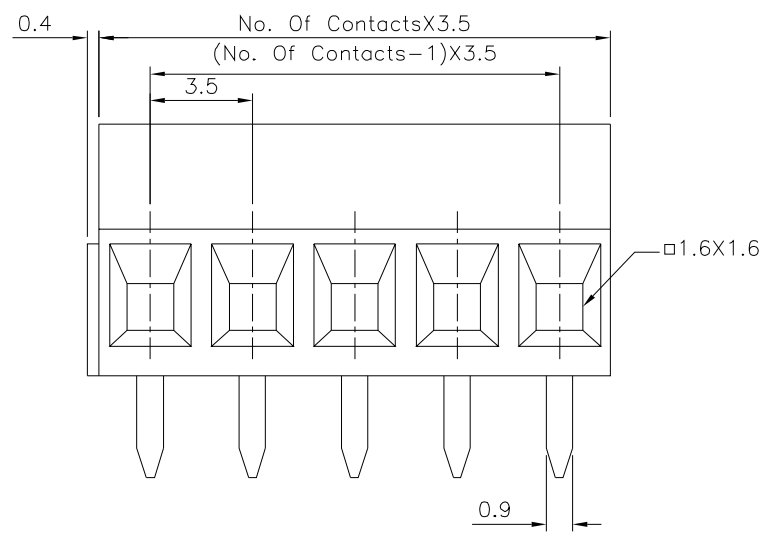

**4UCON** 元化興業股份有限公司  
 4UCON TECHNOLOGY INC.

DRAWING No.		APPROVED BY		UNLESS OTHERWISE SPECIFIED TOLERANCES ARE X. ±0.50 .X ±0.30 .XX ±0.20 X* ±1*
19703		MEI		
		CHECKED BY		
		HZF		
		DRAWING BY		
		CYP		
SCALE	NONE	REV.	BO	UNIT
				mm

NO.	REV.	REVISIONS	CHK	DATE
△	B0	Modify Data	HZF	09/21/2023
△	B0	NEW RELEASE	HZF	09/21/2023