

△△ SPECIFICATION

Voltage Rating:300V AC
 Current Rating:10 Amp/Way Max.
 Contact Resistance:20 Milliohms Max.
 Withstanding Voltage:2500V AC For 1 Minute
 Test Time=60 Sec./1 PCS
 Wire Range:16~30AWG
 Torque:2 Kgf.cm/M2
 Operation Temperature:-40°C~+105°C
 Soldering Reliability:Test Temperature=250°C±10°C
 5 Seconds Max.
 Contact(Metal Housing):Copper Alloy,Nickel Plated
 Solder Pin:Copper Alloy,Tin Plated
 Terminal Screw:Steel,Galvanized With Cr3+ Plated
 Insulator Body(Housing):Polyamide(UL94V-0),Green
 RoHS Compliant

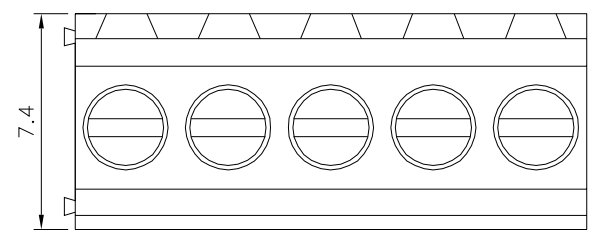

△△△

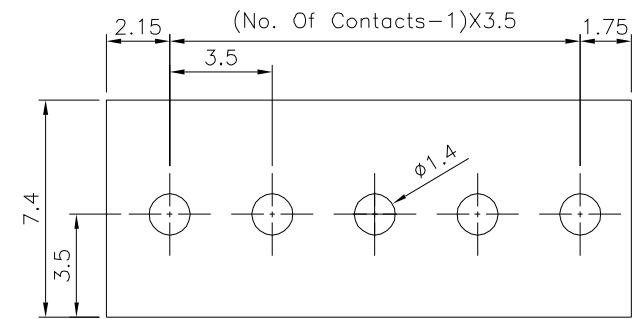

△ Recommended P.C.B. Layout

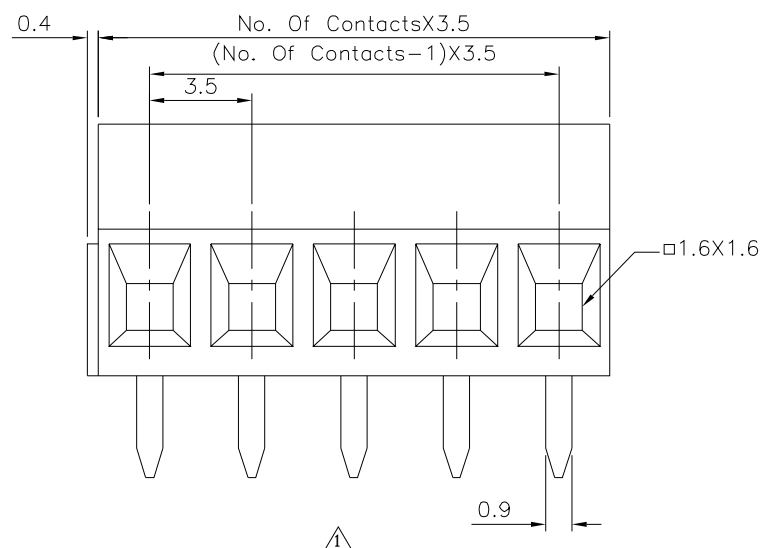

△

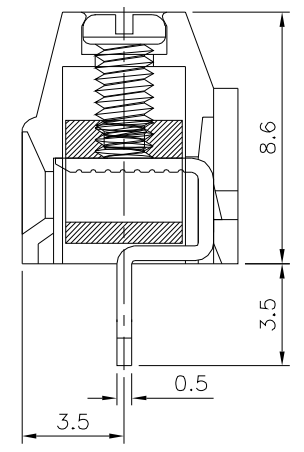

△

4UCON 元化興業股份有限公司
 4UCON TECHNOLOGY INC.

DRAWING No. △
 19716

APPROVED BY MEI
 CHECKED BY HZF
 DRAWING BY CYP

UNLESS OTHERWISE SPECIFIED TOLERANCES ARE
 X. ±0.50
 .X ±0.30
 .XX ±0.20
 X° ±1°

△	A4	Modify Data	HZF	02/13/2017
△	A3	Modify Data	HZF	11/24/2016
△	A2	Modify Data	HZF	02/14/2014
△	A1	Modify Data	HZF	05/13/2010
△	A0	NEW RELEASE	HZF	04/07/2009
NO. REV.	REVISIONS		CHK	DATE

SCALE NONE REV. A4

UNIT mm