

Recommended P.C.B. Layout

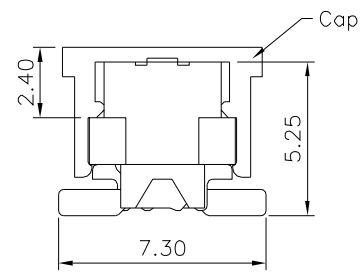

**SPECIFICATION**

Current Rating:1.0A AC/DC  
 Voltage Rating:30V AC/DC  
 Contact Resistance:20 Milliohms Max.  
 Insulation Resistance:1000 Megaohms Min.  
 Withstanding Voltage:500V AC/Minute  
 Operation Temperature Range:-40°C~+105°C  
 Insulator:PA46(UL94V-0),Red  
 Contact:Phosphor Bronze,Tin Plated  
 RoHS Compliant

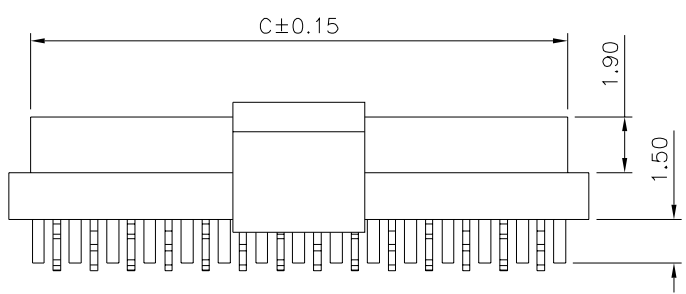
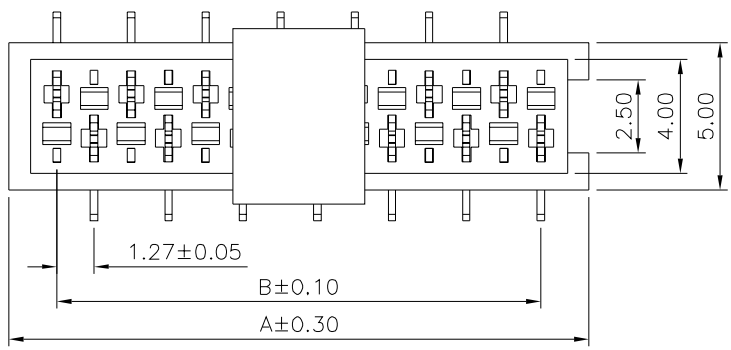

Pin	A	B	C
04	7.00	3.81	5.60
06	9.54	6.35	8.14
08	12.08	8.89	10.68
10	14.62	11.43	13.22
12	17.16	13.97	15.76
14	19.70	16.51	18.30
16	22.24	19.05	20.84
18	24.78	21.59	23.38
20	27.32	24.13	25.92
22	29.86	26.67	28.46
24	32.40	29.21	31.00
26	34.94	31.75	33.54

**4UCON** 元化興業股份有限公司  
 4UCON TECHNOLOGY INC.

DRAWING No.		APPROVED BY		UNLESS OTHERWISE SPECIFIED TOLERANCES ARE .X ±0.2 .XX ±0.15 ANG.
20097		MEI		
		CHECKED BY	HZF	
		DRAWING BY	CYP	
SCALE	NONE	REV.	A2	UNIT mm

NO.	REV.	REVISIONS	CHK	DATE
2	A2	Modify Data	HZF	09/25/2017
1	A1	Modify Data	HZF	11/16/2011
0	A0	NEW RELEASE	HZF	07/11/2009