

SPECIFICATION
 Current Rating:1.0A AC/DC
 Voltage Rating:30V AC/DC
 Withstanding Voltage:500V AC/Minute
 Contact Resistance:20 Milliohms Max.
 Insulation Resistance:1000 Megaohms Min.
 Operation Temperature:-40°C~+105°C
 Contact:Phosphor Bronze,Tin Plated
 Insulator:PA46(UL94V-0),Red
 RoHS Compliant

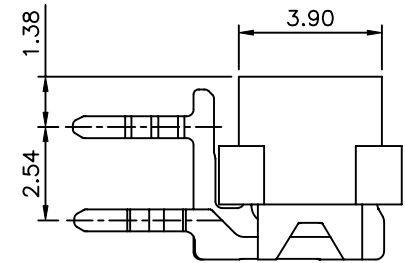
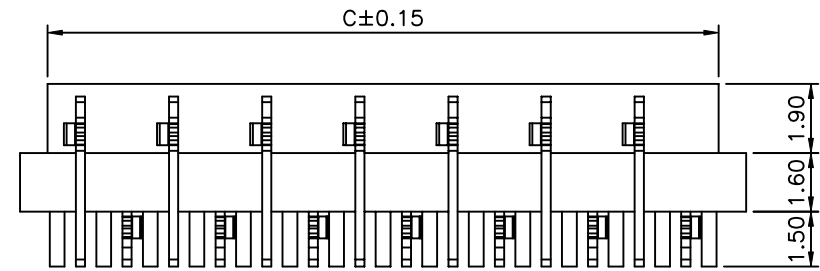
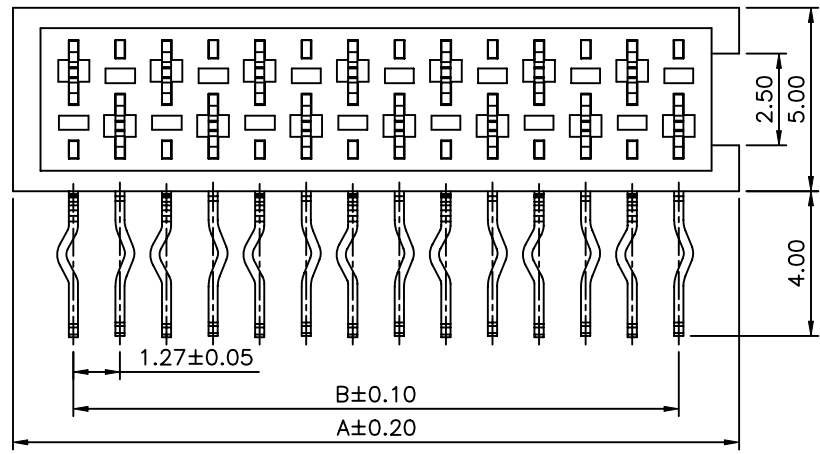
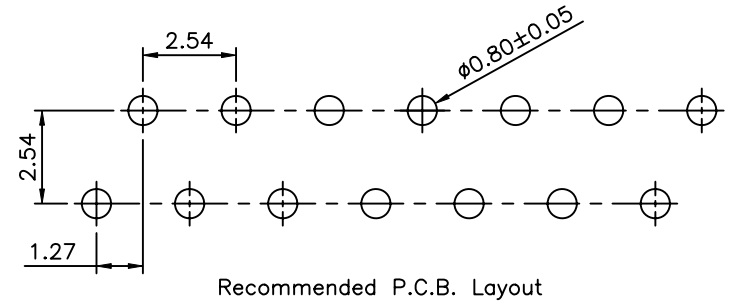

Pin	A	B	C
4	7.00	3.81	5.60
6	9.54	6.35	8.14
8	12.08	8.89	10.68
10	14.62	11.43	13.22
12	17.16	13.97	15.76
14	19.70	16.51	18.30
16	22.24	19.05	20.84
18	24.78	21.59	23.38
20	27.32	24.13	25.92
22	29.86	26.67	28.46
24	32.40	29.21	31.00
26	34.94	31.75	33.54

4UCON 元化興業股份有限公司
 4UCON TECHNOLOGY INC.

DRAWING No. 20102
 APPROVED BY EMILY
 CHECKED BY HZF
 DRAWING BY WSS
 SCALE NONE
 REV. A0

UNLESS OTHERWISE SPECIFIED TOLERANCES ARE
 .X ±0.2
 .XX ±0.15
 UNIT mm

NO.	REV.	REVISIONS	CHK	DATE
△ A0		NEW RELEASE	HZF	09/21/2010

SPECIFICATION
 All Dim. Meet EIA-481-3 Requirements
 Material:Black Conductive Polystyrene Alloy
 100% Recyclable
 Q'ty:400 PCS/Reel
 RoHS Compliant

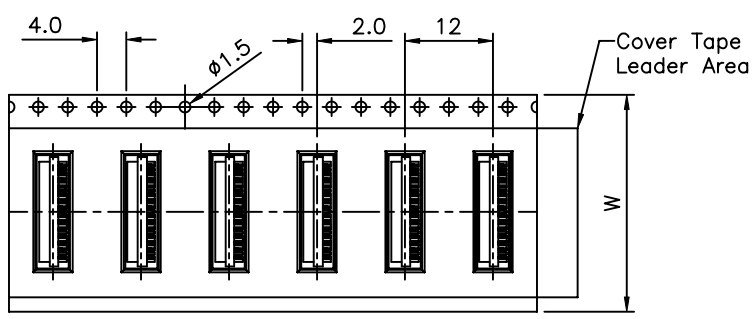

For Reel Width(Dimension W)16,24mm,Single Row Hole

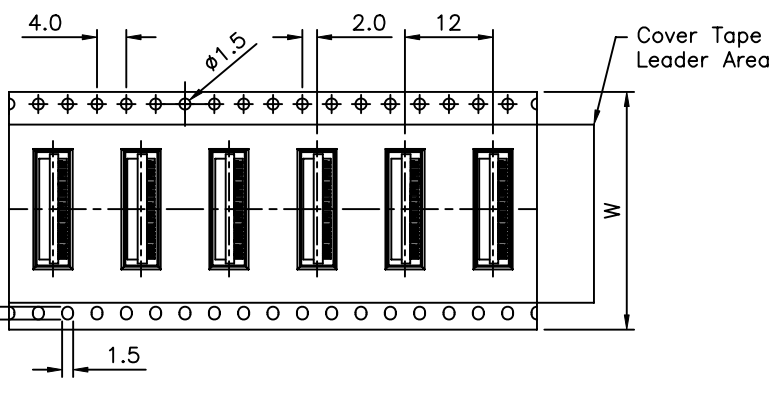
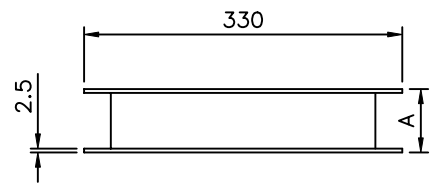
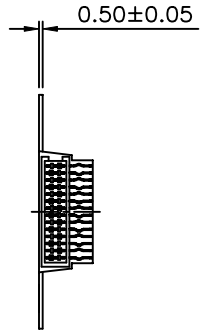

For Reel Width(Dimension W)32,44,56mm Double Row Hole

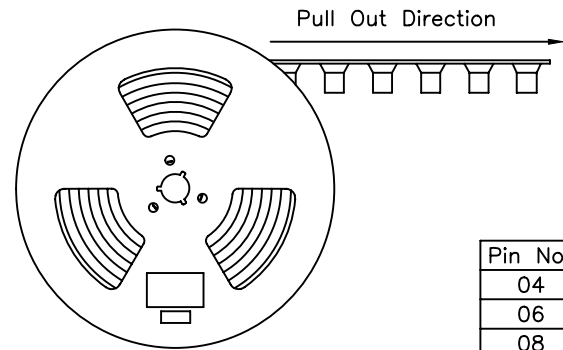
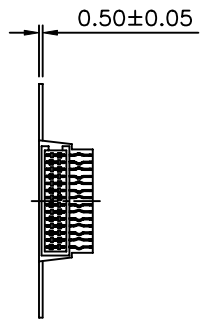

Pin No.	W	A
04	16	21
06	24	29
08	24	29
10	24	29
12	32	37
14	44	49
16	44	49
18	44	49
20	44	49
22	44	49
24	44	49
26	56	61

4UCON 元化興業股份有限公司
 4UCON TECHNOLOGY INC.

DRAWING No.		APPROVED BY		UNLESS OTHERWISE SPECIFIED TOLERANCES ARE .X ±0.2 .XX ±0.15
20102		EMILY		
		HZF		
		DRAWING BY		
		WSS		
SCALE	NONE	REV.	A0	UNIT mm

NO.	REV.	REVISIONS	CHK	DATE
△ A0		NEW RELEASE	HZF	09/21/2010