

**△ SPECIFICATION**

Voltage Rating:300V AC  
 Current Rating:10 Amp/Way Max.  
 Contact Resistance:20 Milliohms Max.  
 Withstanding Voltage:2500V AC For 1 Minute  
 Test Time=60Sec./1 PCS

Wire Range:16~30 AWG  
 Torque:2 Kgf.cm/M2

**△ Operation Temperature:-40°C~+105°C**  
 Soldering Reliability:Test Temperature=250°C±10°C  
 5 Seconds Max.

Contact(Metal Housing):Copper Alloy,Nickel Plated  
 Solder Pin:Copper Alloy,Tin Plated  
 Terminal Screw:Steel,Galvanized,Cr3+ Plated  
 Insulator Body(Housing):Polyamide(UL94V-0)  
 Green

RoHS Compliant

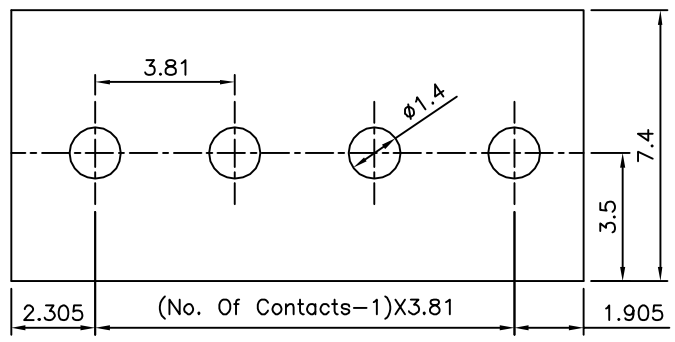
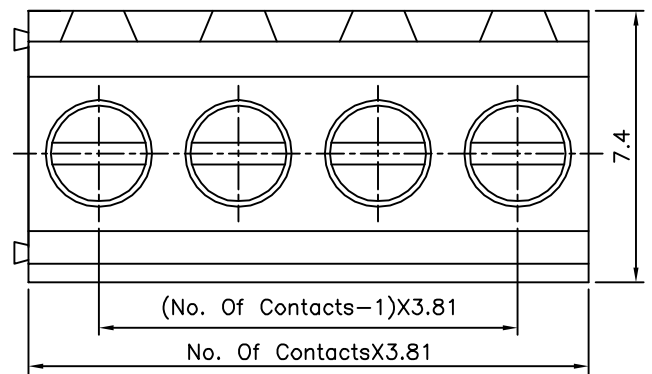

**△ Recommended P.C.B. Layout**

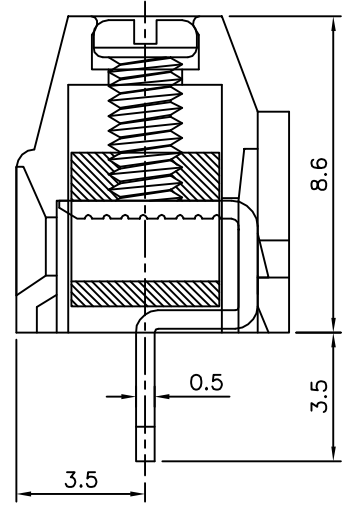
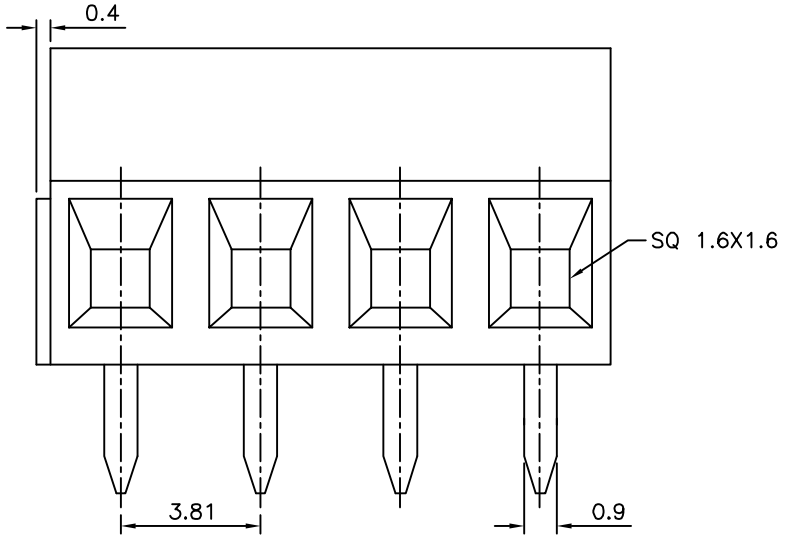

**4UCON** 元化興業股份有限公司  
 4UCON TECHNOLOGY INC.

DRAWING No.		APPROVED BY		UNLESS OTHERWISE SPECIFIED TOLERANCES ARE X. ±0.50 .X ±0.30 .XX ±0.20 ANG. ±1°
20603		EMILY		
		CHECKED BY		
		HZF		
		DRAWING BY		
		HAO		
SCALE	NONE	REV.	A2	UNIT
				mm

NO.	REV.	REVISIONS	CHK	DATE
△ A2		Modify Data	HZF	11/06/2014
△ A1		Modify Data	HZF	07/05/2011
△ A0		NEW RELEASE	HZF	04/15/2010