

SPECIFICATION

Current Rating:3 Amp
 Withstand Voltage:500V AC/Minute
 Contact Resistance:20 Milliohms Max.
 Insulation Resistance:1000 Megaohms Min.
 Operation Temperature:-40°C~+105°C
 Insulator:PA6T+30%G.F.(UL94V-0),Black
 Contact:Phosphor Bronze,Gold Flash Over Nickel
 RoHS Compliant

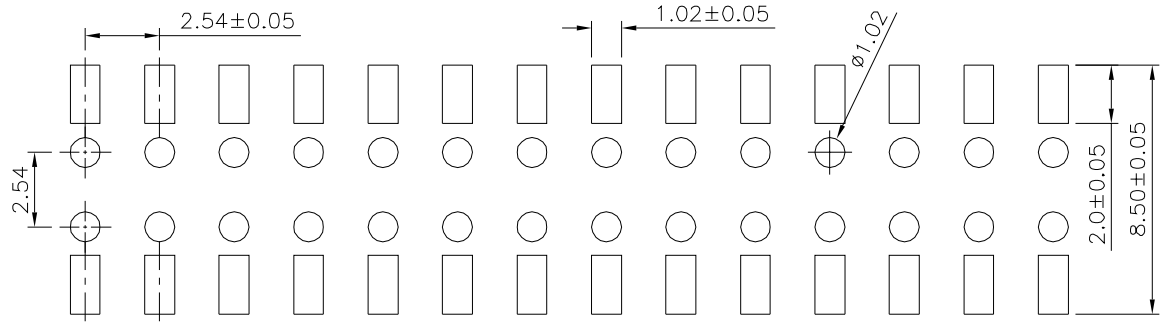

Recommended P.C.B. Layout
 (PCB Board Tolerance±0.05)

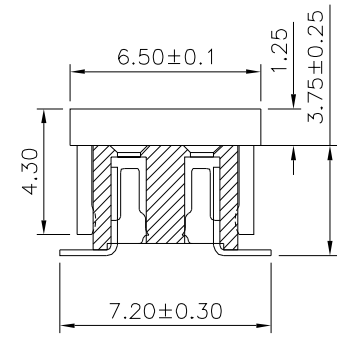
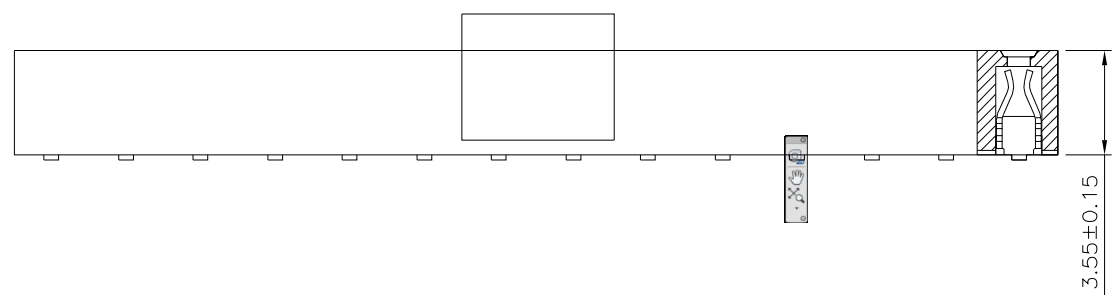
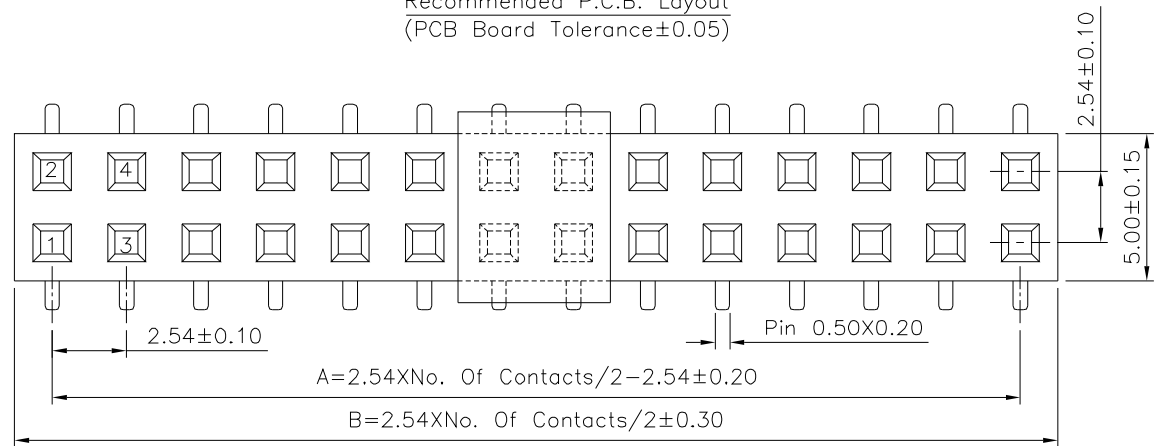

Pin	A	B	Pin	A	B
04	2.54	5.08	44	53.34	55.88
06	5.08	7.62	46	55.88	58.42
08	7.62	10.16	48	58.42	60.96
10	10.16	12.70	50	60.96	63.50
12	12.70	15.24	52	63.50	66.04
14	15.24	17.78	54	66.04	68.58
16	17.78	20.32	56	68.58	71.12
18	20.32	22.86	58	71.12	73.66
20	22.86	25.40	60	73.68	76.20
22	25.40	27.94	62	76.20	78.74
24	27.94	30.48	64	78.74	81.28
26	30.48	33.02	66	81.28	83.82
28	33.02	35.56	68	83.82	86.36
30	35.56	38.10	70	86.36	88.90
32	38.10	40.64	72	88.90	91.44
34	40.64	43.18	74	91.44	93.98
36	43.18	45.72	76	93.98	96.52
38	45.72	48.26	78	96.52	99.06
40	48.26	50.80	80	99.06	101.60
42	50.80	53.34			

4UCON 元化興業股份有限公司
 4UCON TECHNOLOGY INC.

DRAWING No.		APPROVED BY	
22191		MEI	
		CHECKED BY	
		HZF	
DRAWING BY		CYP	
SCALE	NONE	REV.	A0

UNLESS OTHERWISE SPECIFIED TOLERANCES ARE
 .X ±0.30
 .XX ±0.20
 ANG.

UNIT mm

△ A0	NEW RELEASE	HZF	03/21/2018
NO.REV.	REVISIONS	CHK	DATE