

**△△ SPECIFICATION**

Current Rating:5A AC,DC  
 Voltage Rating:250V AC,DC  
 Withstanding Voltage:1500V AC/Minute  
 Insulation Resistance:1000 Megaohms Min.  
 Temperature Range:-25°C~+85°C  
 Material:PA66(UL94V-2)  
 RoHS Compliant

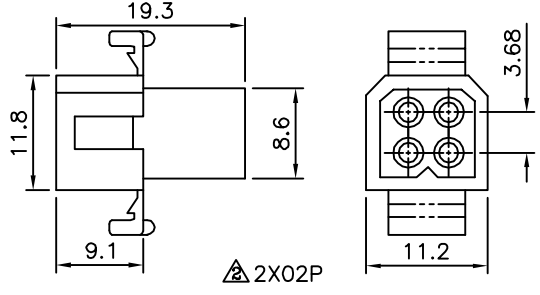
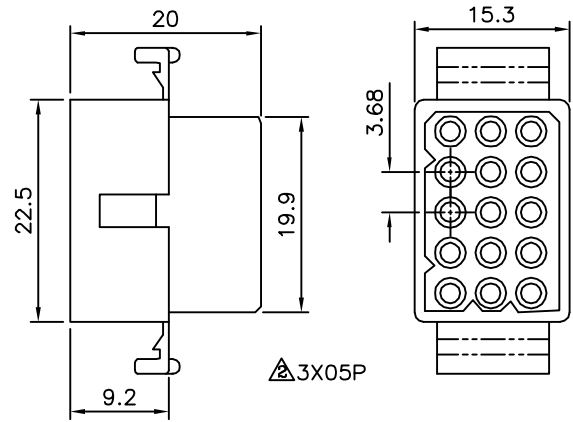
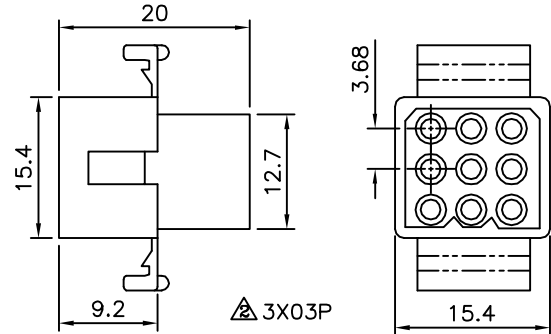
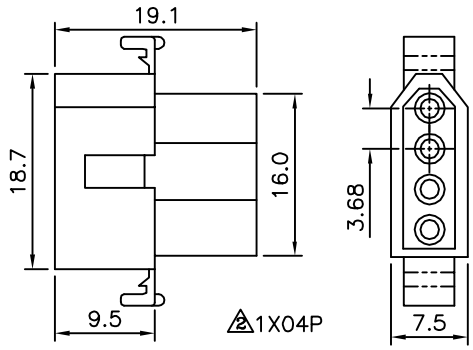
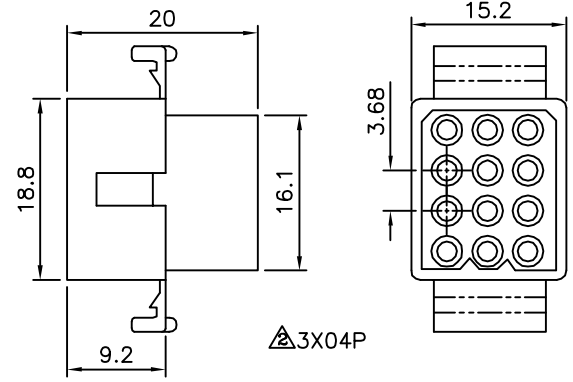
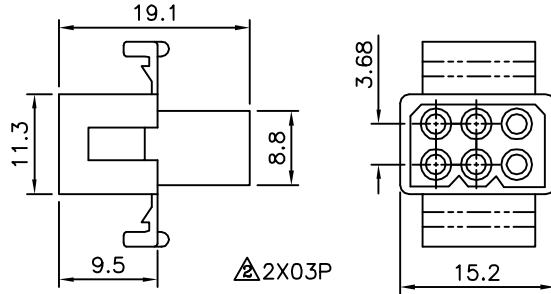
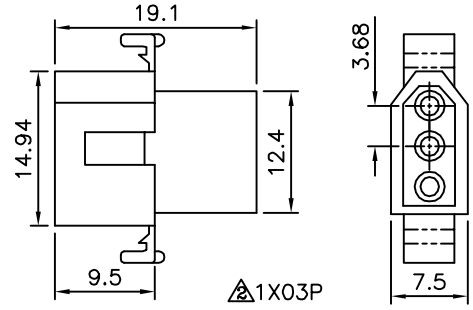
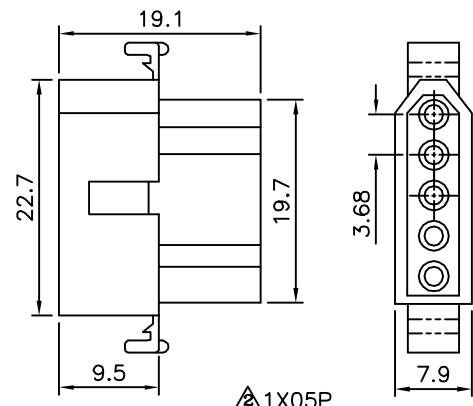
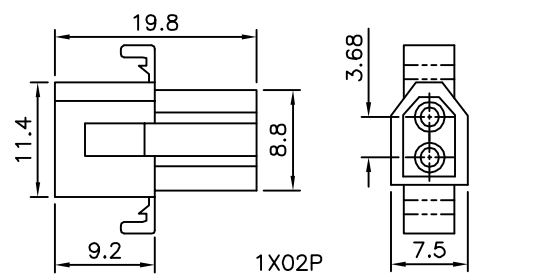

**4UCON** 元化興業股份有限公司  
 4UCON TECHNOLOGY INC.

DRAWING No.		APPROVED BY		UNLESS OTHERWISE SPECIFIED TOLERANCES ARE X. ±0.3 .X ±0.3 △△
02107		EMILY		
		CHECKED BY		
		HZF		
		DRAWING BY		
		SONG		
SCALE	NONE	REV.	A2	UNIT mm

NO.	REV.	REVISIONS	CHK	DATE
△A2		Modify Data	HZF	07/01/2014
△A1		Modify Data	HZF	08/01/2009
△A0		NEW RELEASE		