

**SPECIFICATION**  
 ▲ Insulator:ABS(UL94HB)  
 Screw,Nut&SR:Steel,Nickel Plated  
 Packing:1 Set/Bag  
 RoHS Compliant

▲ Hood Insulator Color	Item No.
Chromate Plated	06896
Gray	06897

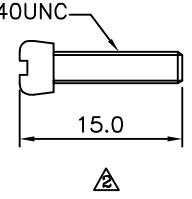
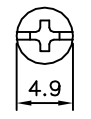
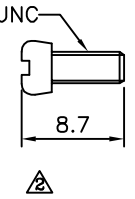
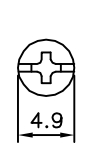
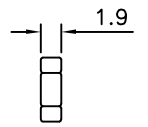
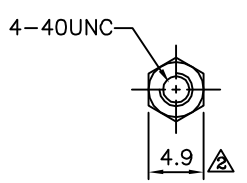
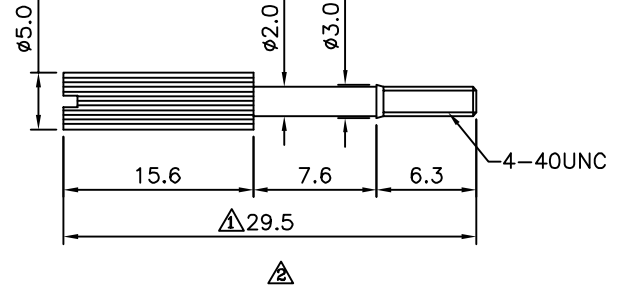
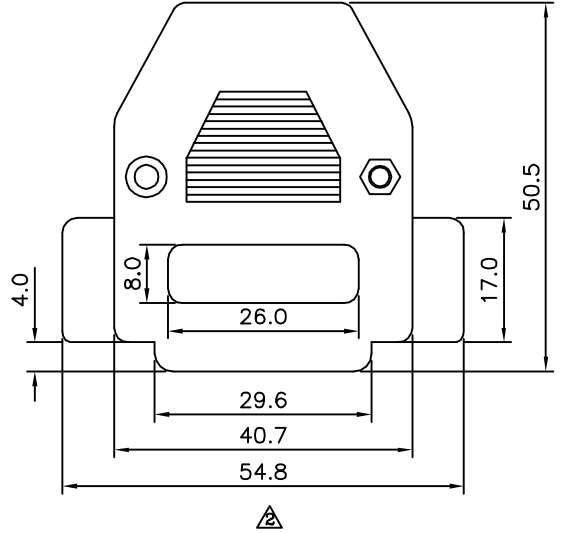
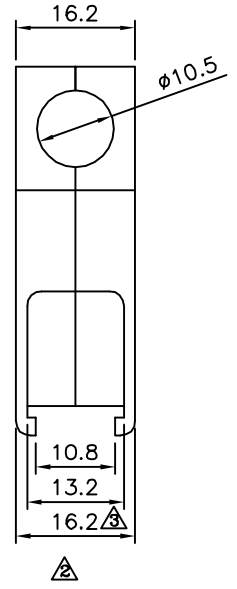
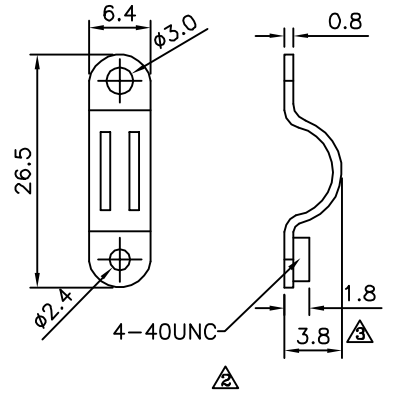
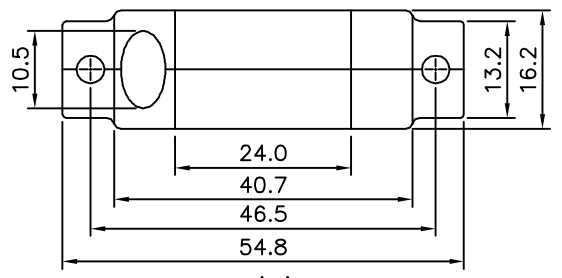

**4UCON** 元化興業股份有限公司  
 4UCON TECHNOLOGY INC.

DRAWING No.		APPROVED BY		UNLESS OTHERWISE SPECIFIED TOLERANCES ARE X. ±0.5 .X ±0.3 .XX ±0.2 ANG. ±5°
06896		EMILY		
		CHECKED BY		
		HZF		
		DRAWING BY		UNIT mm
		SAN		
SCALE	NONE	REV.	A3	

NO.	REV.	REVISIONS	CHK	DATE
▲ A3		Modify Data	HZF	07/16/2014
▲ A2		Modify Data	HZF	10/05/2011
▲ A1		Modify Data	HZF	12/10/2008
▲ A0		NEW RELEASE	HZF	02/07/2008