

**SPECIFICATION**  
 △ Insulator:ABS(UL94HB)  
 Screw,Nut&SR:Steel,Nickel Plated  
 Packing:1 Set/Bag  
 RoHS Compliant

△ Hood Insulator Color	Item No.
Chromate Plated	06896
Gray	06897

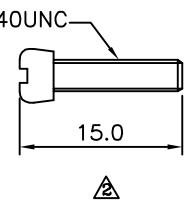
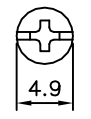
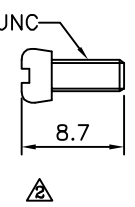
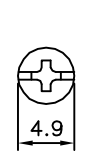
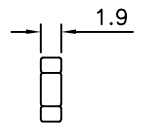
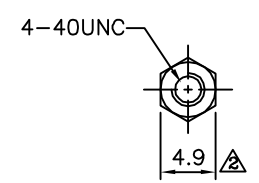
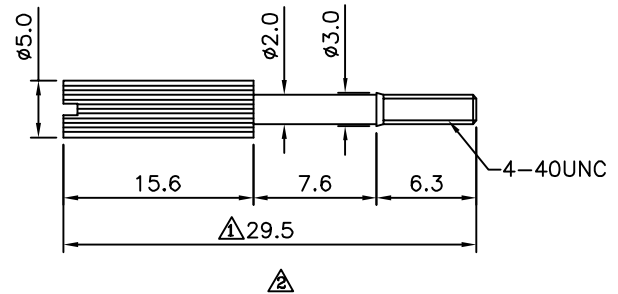
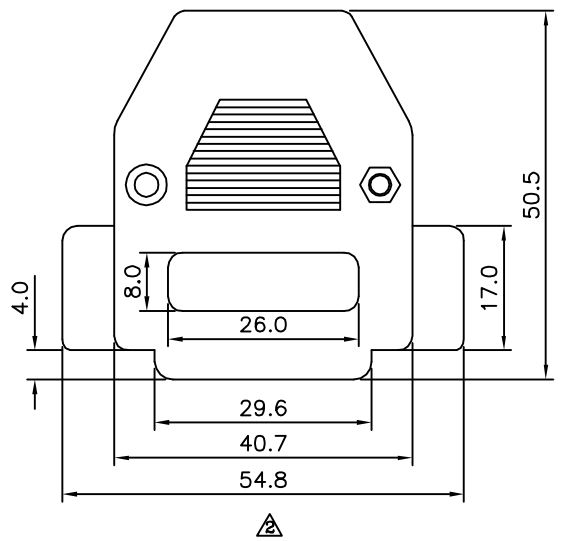
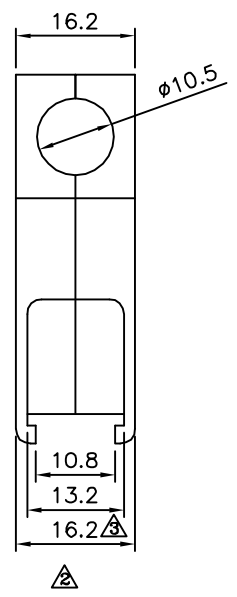

**4UCON** 元化興業股份有限公司  
 4UCON TECHNOLOGY INC.

DRAWING No.		APPROVED BY		UNLESS OTHERWISE SPECIFIED TOLERANCES ARE △ X. ±0.5 .X ±0.3 .XX ±0.2 ANG. ±5°
06897		EMILY		
		CHECKED BY		
		HZF		
		DRAWING BY		
		SAN		
SCALE	NONE	REV.	A3	UNIT
				mm

NO.	REV.	REVISIONS	CHK	DATE
△ A3		Modify Data	HZF	07/16/2014
△ A2		Modify Data	HZF	10/05/2011
△ A1		Modify Data	HZF	12/10/2008
△ A0		NEW RELEASE	HZF	02/07/2008