

△ SPECIFICATION

- △△ 1. General Characteristics:**
1.25mm FPC XXP DIP 90° ZIF Upper
Contact Standard Layout White Insulator
- 2. Material&Finish:**
Housing:PBT(UL94V-0),White
Terminal:Phosphor Bronze,Tin Plated Over Nickel
- 3. Electrical Characteristics**
Current Rating:1 Amp AC/DC
Voltage Rating:200V AC/DC
Contact Resistance:20 Milliohms Max.
Insulation Resistance:500 Megaohms Min.
Dielectric Strength:500V AC For 1 Minute
- 4. Environmental Characteristics**
Temperature Range:-20°C~+85°C
- 5. RoHS Compliant**

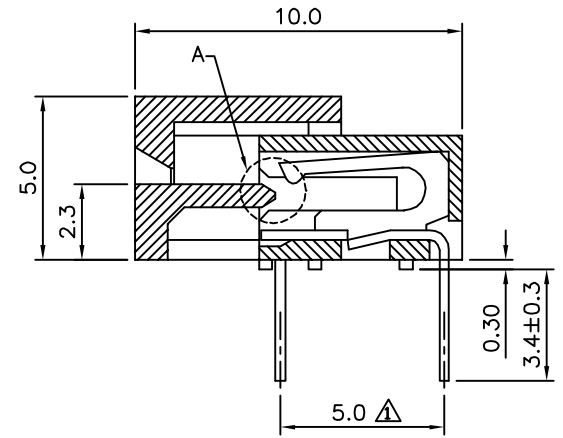

△ Open Type

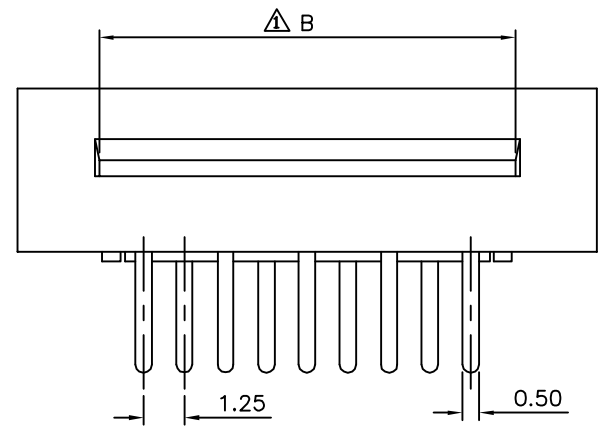
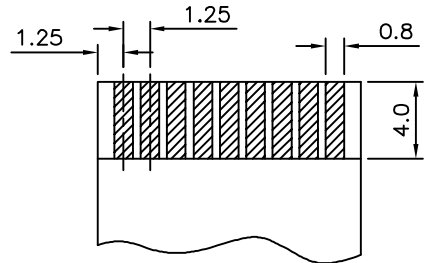
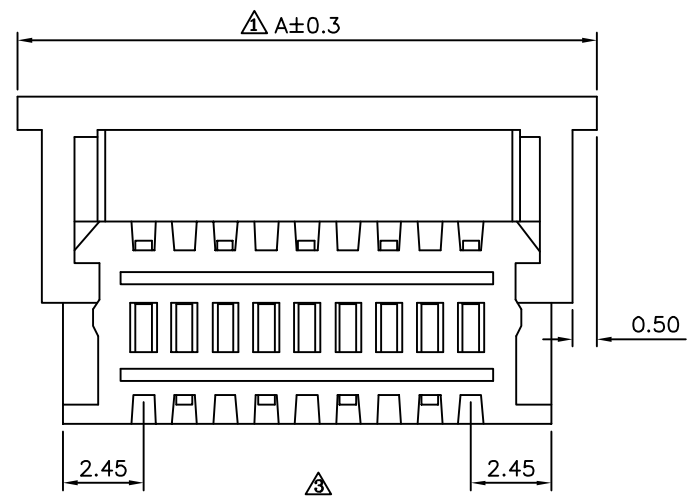

FFC/FPC Dimension
Thickness 0.3±0.05mm

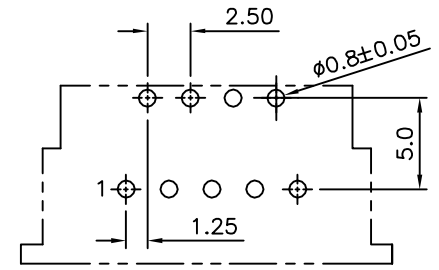

Recommended P.C.B. Layout
Component Side

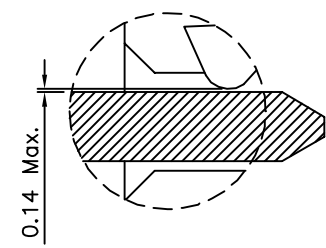

Detail A
Close Type

Pin	A	B
3	9.55	5.20
4	10.80	6.45
5	12.05	7.70
6	13.30	8.95
7	14.55	10.20
8	15.80	11.45
9	17.05	12.70
10	18.30	13.95
11	19.55	15.20
12	20.80	16.45
13	22.05	17.70
14	23.30	18.95
15	24.55	20.20
16	25.80	21.45
17	27.05	22.70
18	28.30	23.95
19	29.55	25.20
20	30.80	26.45
21	32.05	27.70
22	33.30	28.95
23	34.55	30.20
24	35.80	31.45
25	37.05	32.70
26	38.30	33.95
27	39.55	35.20
28	40.80	36.45
29	42.05	37.70
30	43.30	38.95
31	44.55	40.20
32	45.80	41.45

4UCON 元化興業股份有限公司
4UCON TECHNOLOGY INC.

DRAWING No.		APPROVED BY		UNLESS OTHERWISE SPECIFIED TOLERANCES ARE .X ±0.30 .XX ±0.25 .XXX ±0.15 ANG. ±3°	△ A4 Modify Data △ A3 Modify Data △ A2 Modify Data △ A1 Modify Data △ A0 NEW RELEASE	HZF	05/29/2015	
08822		EMILY						
		HAO						
SCALE	NONE	REV.	A4	UNIT mm	NO. REV.	REVISIONS	CHK	DATE