

Recommended P.C.B. Layout

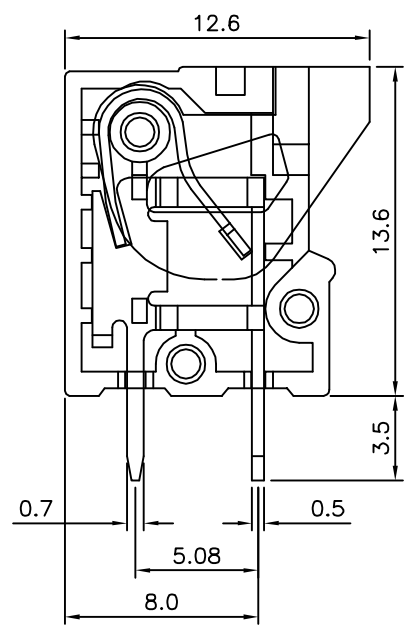
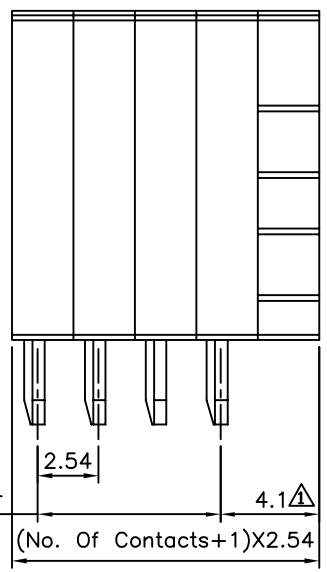

△△ SPECIFICATION
 Current Rating:2 Amp/Way Max.
 Voltage Rating:150V AC
 Withstanding Voltage:2000V AC(1 Minute)
 Test Time=60s/PCS
 Contact Resistance:20 Milliohms Max.
 Wire Range:20~26 AWG
 Operation Temperature:-40°C~+105°C
 Test Temperature:250°C 5 Seconds Max.
 Wire Guard:Stainless Steel
 Surface Of Solder Tails:Copper Alloy,Tin Plated
 Insulator Body(Housing):Polyamide+G.F.(UL94V-0),Green
 RoHS Compliant

4UCON 元化興業股份有限公司
 4UCON TECHNOLOGY INC.

DRAWING No.		APPROVED BY		UNLESS OTHERWISE SPECIFIED TOLERANCES ARE X. ±0.50 .X ±0.30 .XX ±0.20 ANG. ±1°
11386		EMILY		
		CHECKED BY HZF		
		DRAWING BY SONG		
SCALE	NONE	REV.	A2	UNIT mm

NO.	REV.	REVISIONS	CHK	DATE
△A2		Modify Data	HZF	09/10/2013
△A1		Modify Data	HZF	01/06/2012
△A0		NEW RELEASE	HZF	05/23/2009