

SPECIFICATION

1. General Characteristics
0.3mm FPC XXP SMT 90° Easy On Type Bottom
Contact H=1.0mm Tape & Reel 5000 PCS/Reel
2. Material & Finish
Housing: LCP(UL94V-0), Natural
Actuator: LCP(UL94V-0), Black
Contact: Phosphor Bronze, Gold Flash Over All, Over Nickel
Leg: Phosphor Bronze, Tin Plated Over Nickel
3. Electrical Characteristics
Voltage Rating: 30V AC/DC
Current Rating: 0.2A AC/DC
4. Environmental Characteristics
Temperature Rating: -55°C ~ +85°C
5. RoHS Compliant

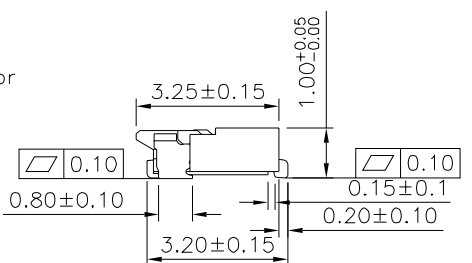
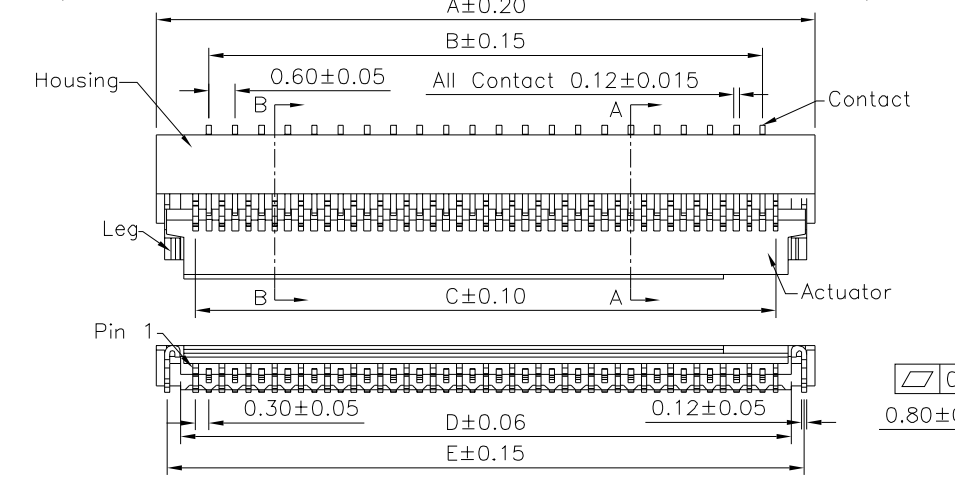
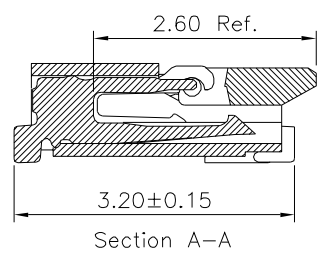
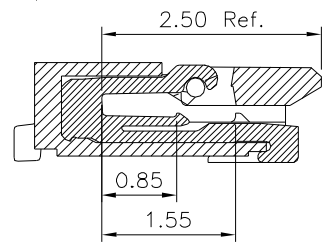
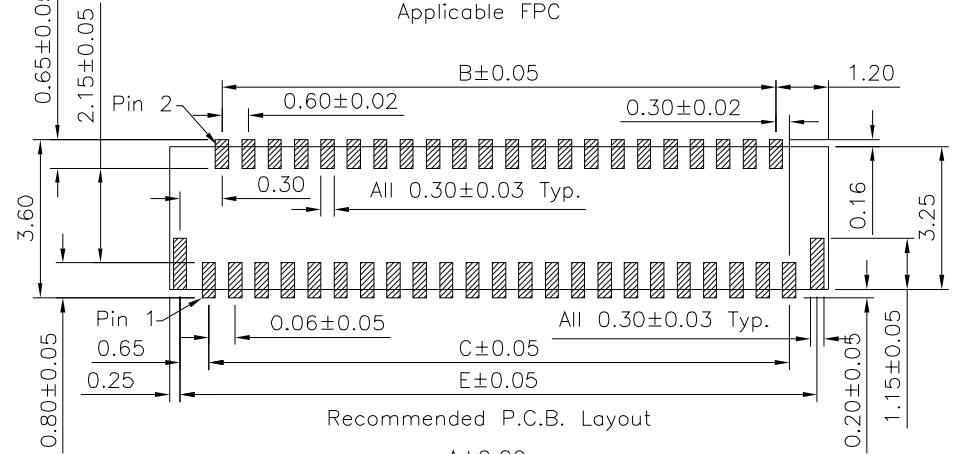
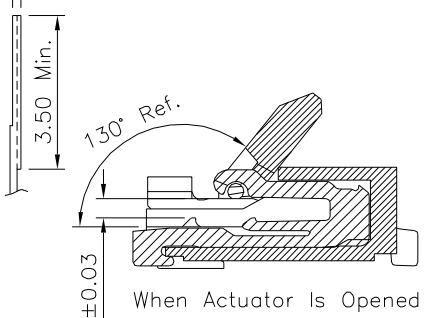
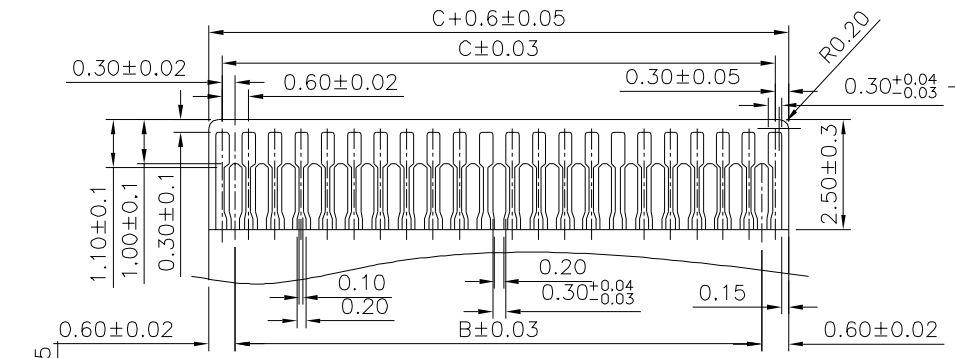

Pin	A	B	C	D	E
*13	5.40	3.00	3.60	4.25	4.90
*15	6.00	3.60	4.20	4.85	5.50
*17	6.60	4.20	4.80	5.45	6.10
*19	7.20	4.80	5.40	6.05	6.70
*21	7.80	5.40	6.00	6.65	7.30
*23	8.40	6.00	6.60	7.25	7.90
*25	9.00	6.60	7.20	7.85	8.50
*27	9.60	7.20	7.80	8.45	9.10
29	10.20	7.80	8.40	9.05	9.70
*31	10.80	8.40	9.00	9.65	10.30
*33	11.40	9.00	9.60	10.25	10.90
*35	12.00	9.60	10.20	10.85	11.50
37	12.60	10.20	10.80	11.45	12.10
*39	13.20	10.80	11.40	12.05	12.70
*41	13.80	11.40	12.00	12.65	13.30
*45	15.00	12.60	13.20	13.85	14.50
49	16.20	13.80	14.40	15.05	15.70
*51	16.80	14.40	15.00	15.65	16.30
57	18.60	16.20	16.80	17.45	18.10
*61	19.80	17.40	18.00	18.65	19.30
*67	21.60	19.20	19.80	20.45	21.10
71	22.80	20.40	21.00	21.65	22.30
73	23.40	21.00	21.60	22.25	22.90

The Mark Of "*" Are Tooled Already

4UCON 元化興業股份有限公司
4UCON TECHNOLOGY INC.

DRAWING No.		APPROVED BY		UNLESS OTHERWISE SPECIFIED TOLERANCES ARE .X ±0.30 .X* ±5° .XX ±0.20 .XX* ±2° .XXX ±0.10 .XXX* ±1°
20049		MEI		
		CHECKED BY		
		HZF		
		DRAWING BY		
		CYP		
SCALE	NONE	REV.	A0	UNIT mm

△ A0	NEW RELEASE	HZF	12/20/2016
NO. REV.	REVISIONS	CHK	DATE