

SPECIFICATION
 Shell: Brass, Nickel Plated
 RoHS Compliant

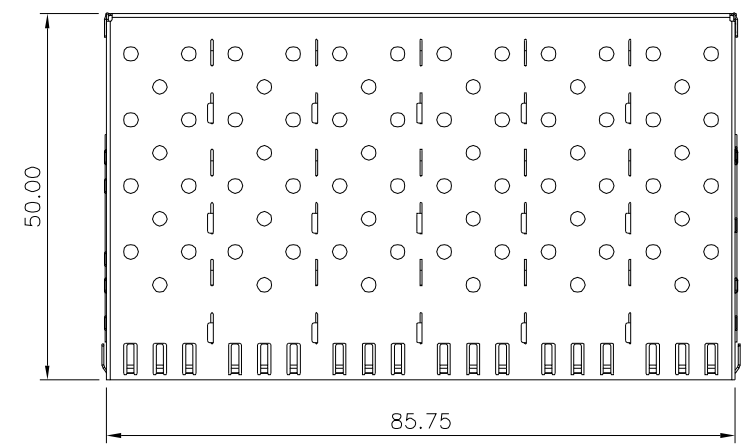
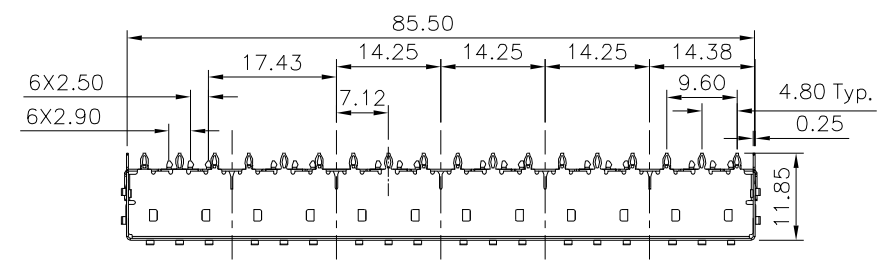
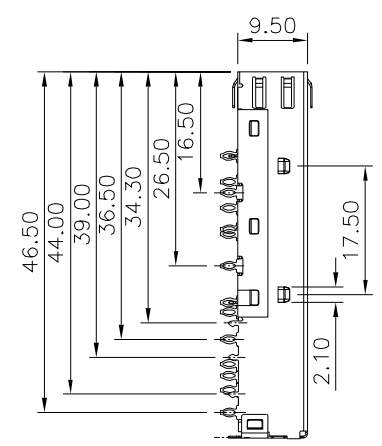
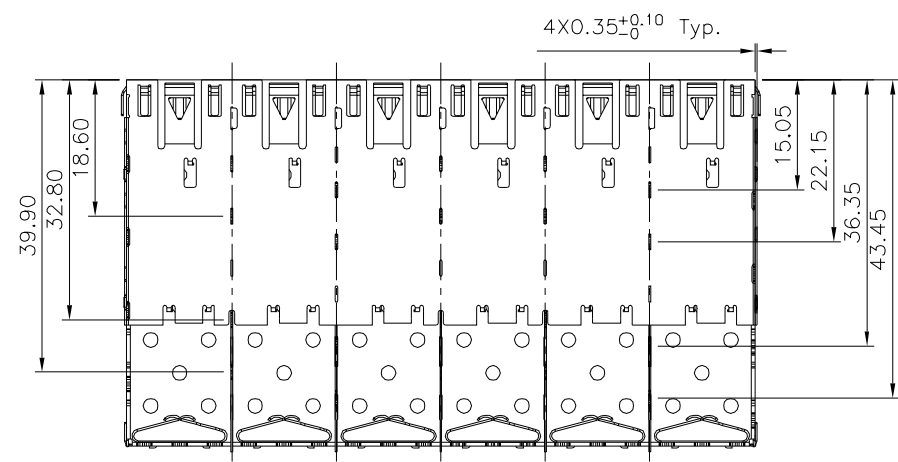
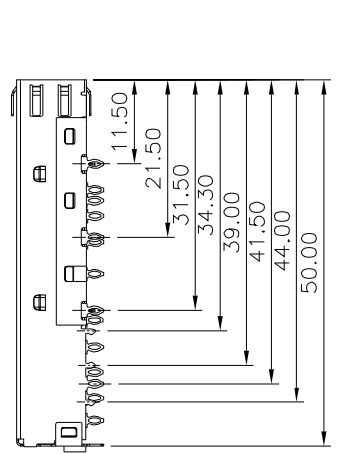

4UCON 元化興業股份有限公司
 4UCON TECHNOLOGY INC.

DRAWING No. 20921
 SCALE NONE

APPROVED BY MEI
 CHECKED BY HZF
 DRAWING BY CYP
 REV. A0

UNLESS OTHERWISE SPECIFIED TOLERANCES ARE
 .X ±0.30
 .XX ±0.20
 .XXX ±0.10
 ANG. ±3°
 UNIT mm

NO.	REV.	REVISIONS	CHK	DATE
△ A0		NEW RELEASE	HZF	05/03/2016

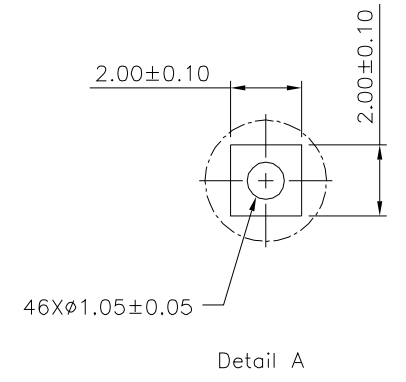
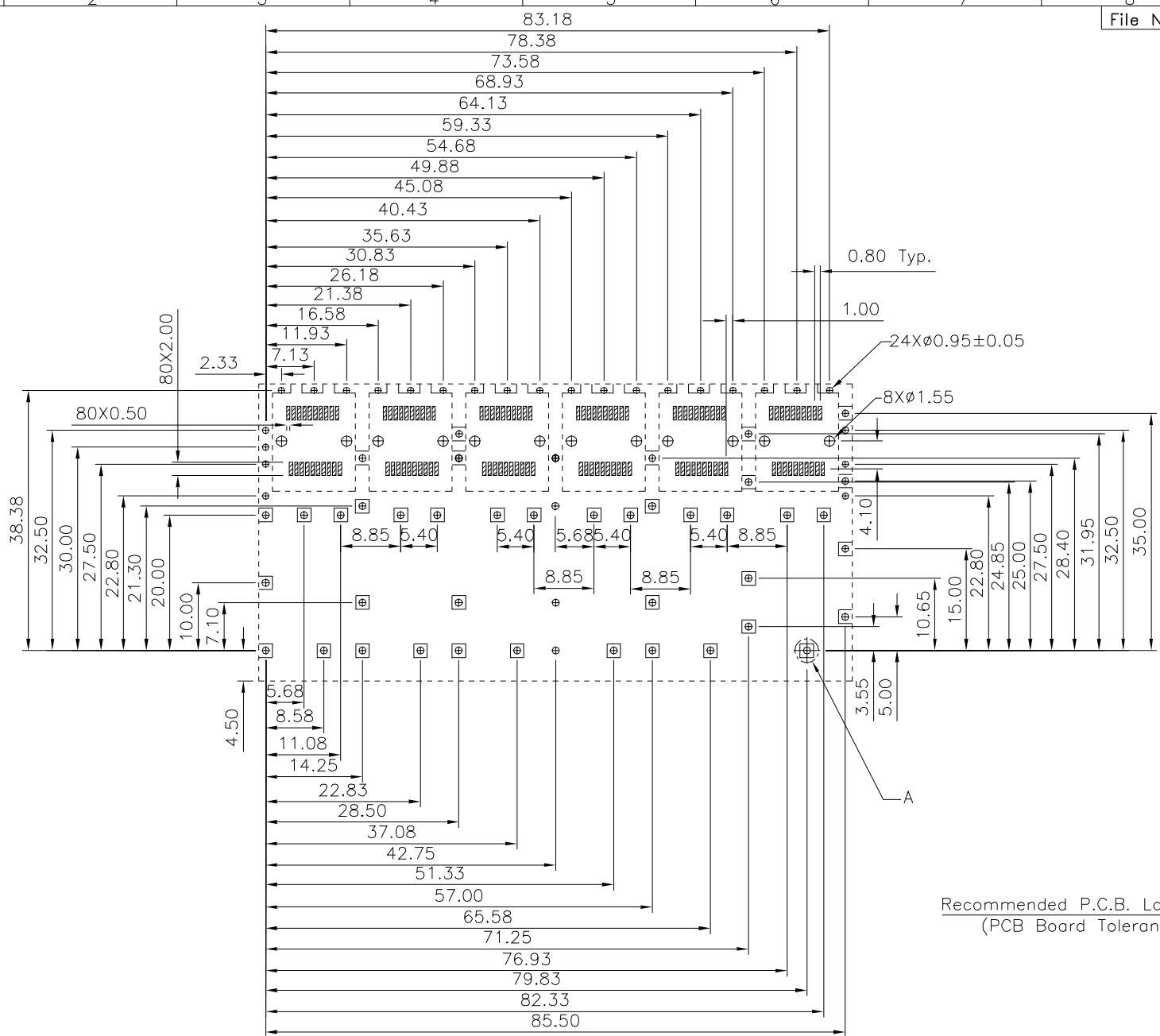

Recommended P.C.B. Layout(Top View)
(PCB Board Tolerance±0.05)

4UCON 元化興業股份有限公司
4UCON TECHNOLOGY INC.

DRAWING No.		APPROVED BY		UNLESS OTHERWISE SPECIFIED TOLERANCES ARE .X ±0.30 .XX ±0.20 .XXX ±0.10 ANG. ±3°					
20921		MEI							
		CHECKED BY							
		DRAWING BY							
SCALE	NONE	REV.	A0	UNIT	mm	△ A0	NEW RELEASE	HZF	05/03/2016
						NO.REV.	REVISIONS	CHK	DATE